

Installation and Operation Manual

August 2020

Congratulations on your SKAARHOJ controller! Our mission is to ease the use of broadcast hardware for people making live video and doing so by means of awesome tactile industrial strength hardware controllers. We are really proud of how much we have been able to stuff into this device, and we hope you can see our love and passion for cool and helpful technology shine through when you browse this manual.

While we really want to make everything intuitive for you, we still need to document some not so obvious facts and conventions and we have tried to put everything you need to know into this document along with a few extra tips too.

Have fun!

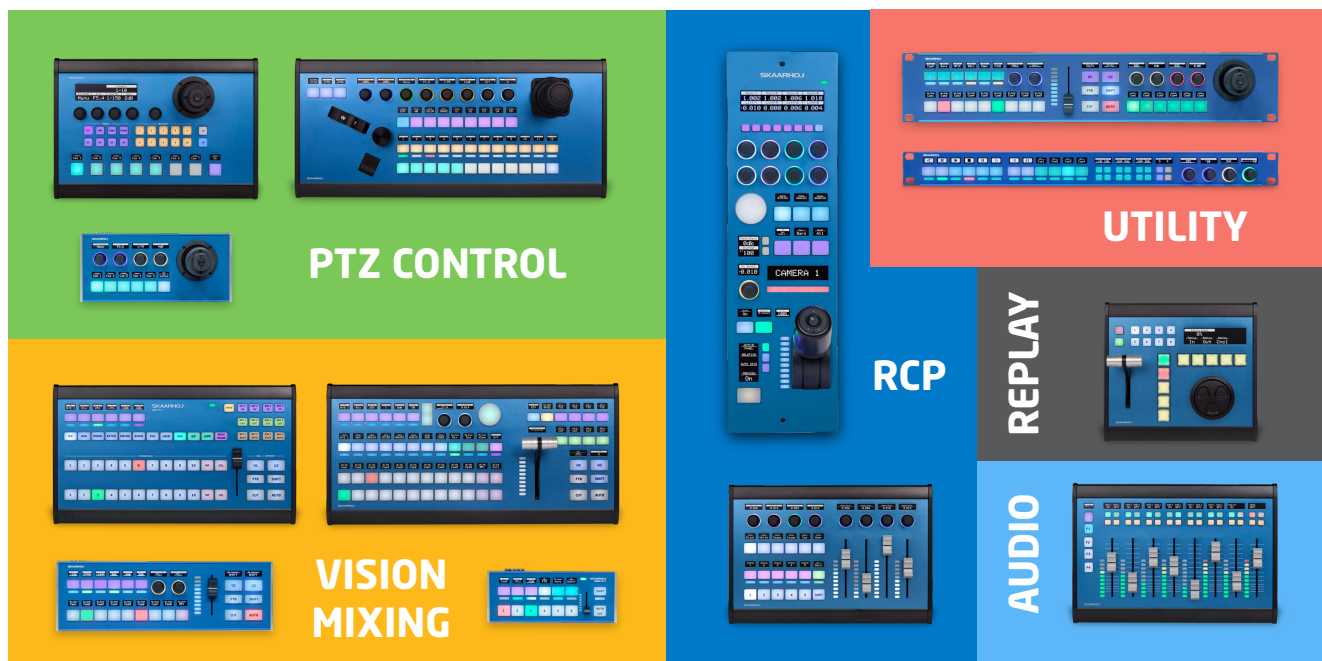

Contents

Installation and Operation Manual	1
Contents	2
Getting Started	4
Additional Information	4
Firmware Updater	6
Connecting SKAARHOJ Controller with Clients	6
Troubleshooting	7
Setting IP for Controllers with Stand alone Firmware	8
ATEM-TCP Link	8
ETH-SDI Link and ETH-LANC Link	8
UniSketch OS	10
Advanced Configuration	11
Device Cores	11
Manage Configurations	12
Manage Media	12
Firmware Overview	12
Device Core Options	13
Device Cores	14
vMix Device Core	14
Firmware Updater Application	15
Update Firmware	16
Online Configuration	16
Local Configuration	17
IP Config	18
Methods of Setting IP Addresses	19
Static IP or DHCP	21
Serial Monitor	23
Commands in the Serial Monitor	24
Load Firmware from File	26
Expert Mode	27
Shortcuts	28
Uploading Error	29
Error on Check: Your controller is not yet registered	30
Network Recommendations	31
Facts	31
Power over Ethernet (PoE) Specifications	31
Troubleshooting	31
Connection Stability and NDI	32
Network Guidelines	32
Multicast Data on Network	33
Recommend Managed Network Switches for NDI Network	33
Back Connections & Pinouts	35

Status LED Overview	36
Pinouts	37
DB-25 Connector Configuration for GPI	37
DB-9 Connector Configuration for RCP units (EXT I/O)	38
Pinout for Tally Box	39
Embedding CCU data on the the 3G-SDI return feed	40
Locking Connector for 12v Power Supply	40
Troubleshooting	41
Cases	41
Recovery Process for Overloaded Controllers	44
Enable Local Configuration by default	45
Controller does not show up under Port in Firmware Application	46
Contact Support	48
UniSketch OS Explained	49
Configuration Page	49
Device Settings	49
Hardware Interface Components (HWC)	50
Graphical Displays	51
Actions	51
Multiple Actions	52
Shift	52
States	53
Virtual Triggers	54
Copy / Paste	54
Auto Fill	54
Presets vs Online Configurations	55
Various Examples:	56
ETH-GPI Link + Controller Server/Client Combinations	56
Triggering Actions from Binary Inputs	56
Connection between RCP and ETH-SDI Link using ETH2SDI Firmware	60
Connection between RCP and WIFI-B4 Link	61
WEEE Information	62

Getting Started

We have two types of controllers:

- Controllers with UniSketch OS
- Controllers with Stand Alone Firmware

How to configure your controller depends on which type it is.

Controllers with UniSketch OS

Is a controller typically with displays, buttons, joysticks such as the PTZ Fly or the RCPv2. The majority of our controllers is with UniSketch OS. The manual focus on these types of controllers with the exception of section: [Setting IP for Controllers with Stand alone Firmware](#).

Controllers with Stand Alone Firmware

Is a small utility box such as the ATEM-TCP Link, ETH-SDI Link and ETH-LANC Link. The relevant section in this manual for these are: [Setting IP for Controllers with Stand alone Firmware](#)

Additional Information

This manual is the Installation and Operation manual. This provides an overview on how to install Configurations on your controller, how to use the Firmware Application and network details. As our controllers are generic in what they can do, we do not have specific manuals for each product.

Please also check out these additional sources of information:

- **Device Core Manuals:** See specific [Device Core manuals](#) (if the exist). They have more details about functionality for what we support
- **PTZ Manual:** See "[PTZ Manual](#)" for details about PTZ control and IP settings
- **Training Videos:** See the [Training Videos](#) on how to get started and how to use UniSketch OS
- **Additional Files:** Go to our [Support Folder](#) on Git for additional resources and files
- **YouTube Videos:** Don't miss out on the latest updates - subscribe to our [YouTube Channel](#)



The majority of this manual use illustrations from our beta version of the Firmware Application, however some graphics are still from the old version. The principles between the application and the beta application are very similar.

For UniSketch OS based controllers a config-slip is included in the package.

1 What configuration is installed?
Make sure this is the one you want. If not, read the next section on how to change it.

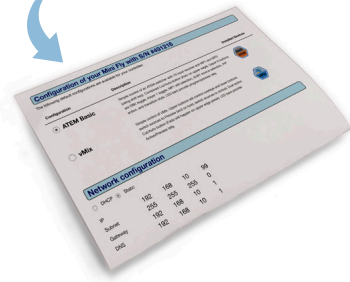

2 What IP addresses are used?
If the configuration is good, but the IP settings don't match your network, you'll have to change them.

Change the controller IP addresses
To set up the IP addresses, click "IP Configuration" in the firmware application.
In the pop-up window, make the IP changes you need, save and power cycle the controller.
You're done!

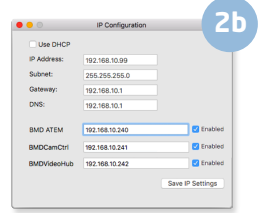

1 Download an entirely different configuration

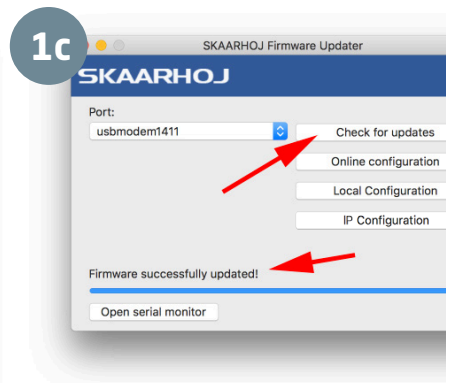
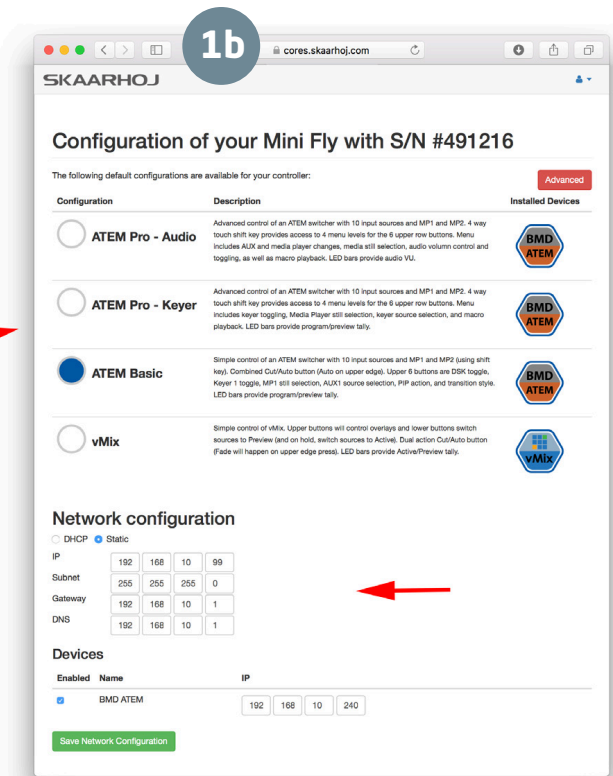
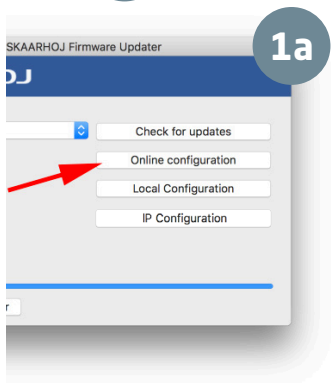

Press "Online Configuration" in the SKAARHOJ Firmware Updater application. A web browser will open.

You'll see the same page printed and included in this cover; Now, select a different configuration and set the corresponding IP addresses.

! Your computer must be connected to the Internet!

The final step to bliss is to go back to the SKAARHOJ Firmware Updater application and press "Check for updates". A new unique firmware with your selected configuration and IP settings is created, downloaded and installed on your controller.

You're done!

! Pro-tip: If you are up for some fun later, notice the "Advanced" button on the web page. Don't click it just yet - but go back there and explore when you have successfully worked with a default configuration.

Having trouble? Visit <http://skaarhoj.com/support>

Default IP configuration for a SKAARHOJ Controller with UniSketch OS when shipping:

- IP Address:** 192.168.10.99
- Subnet:** 255.255.255.00
- Gateway:** 192.168.10.1
- DNS:** 192.168.10.1

Firmware Updater

You won't get far without the SKAARHOJ Firmware Updater application. Download it www.skaarhoj.com/support/firmware-updater/. Install, run it and connect your controller. Please notice the USB cable is only to be used for configuration and firmware upgrade. The USB plug is not designed to be connected during normal operation. More details are found in the "Firmware Updater Application" section of this manual.

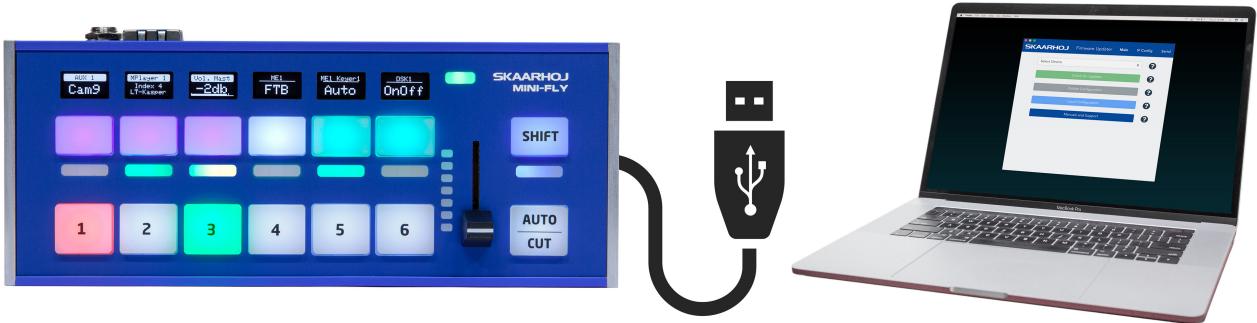

Connect the SKAARHOJ controller to your computer with the included USB cable. The device shows up in the Port list. Only connect one SKAARHOJ controller at a time.

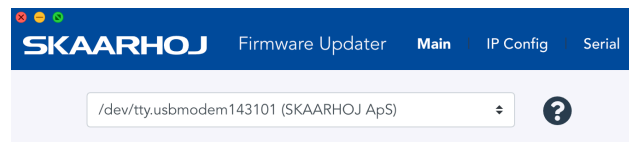

Connecting SKAARHOJ Controller with Clients

Almost all of our controllers are IP based. Below two examples are given for how to connect a SKAARHOJ controller with a client or multiple clients. Notice communication is ethernet based and not via USB. For control of multiple PTZ cameras please read the "PTZ Manual" at www.skaarhoj.com/support/manuals/



If you want to control for example an ATEM switcher you do *not* need a PC/Mac running the ATEM Software Control Panel for using the SKAARHOJ controller since it connects directly to the ATEM. But you can run both at the same time if you want, and the changes made in either the SKAARHOJ controller or in the ATEM Software Control panel will correlate with the other unit. This is the case for most device cores you can install on your controller, but for more information, consult the support pages for the individual device cores.

Troubleshooting

If you have followed the above instructions and still have issues here's some tips

- Check IP and network settings via "IP Config" in the Firmware Application. If the Device Core IP address does not match the client(s) nothing will work
- Double check IP settings! Use the serial monitor to confirm IP address of the controller and clients.
- Consider pressing "Clear Presets". This will remove any presets and IPs stored locally on the controller. Notice: IPs set via the "IP Configuration" will be removed + any local configuration will be removed by this command.
- Use the serial monitor in the Firmware Updater Application to check connection status. Depending on Client type you will get confirmation when clients are connected or not (see illustrations below)
- Avoid having Device Cores enabled if clients does not exist. The controller will use resources trying to connect to non-existing clients.
- SKAARHOJ controller and client must be on the same subnet.
- If connecting to multiple PTZ cameras it is normally not required to install additional Device Cores. Please see the PTZ Manual at www.skaarhoj.com/support/manuals/

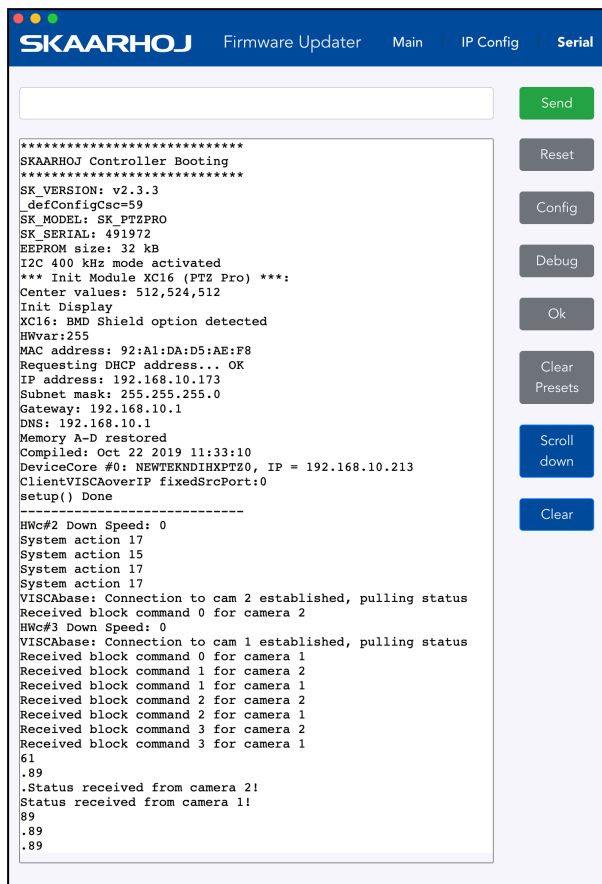

```
SKAARHOJ Firmware Updater Main IP Config Serial
Send
Reset
Config
Debug
Ok
Clear Presets
Scroll down
Clear

*****
SKAARHOJ Controller Booting
*****
SK_VERSION: v2.3.3
_defConfigCsc=59
SK_MODEL: SK_PTZPRO
SK_SERIAL: 491972
EEPROM size: 32 kB
I2C 400 kHz mode activated
*** Init Module XC16 (PTZ Pro) ***:
Center values: 512,524,512
Init Display
XC16: BMD Shield option detected
HWvar:255
MAC address: 92:A1:DA:D5:AE:F8
Requesting DHCP address... OK
IP address: 192.168.10.173
Subnet mask: 255.255.255.0
Gateway: 192.168.10.1
DNS: 192.168.10.1
Memory A-D restored
Compiled: Oct 22 2019 11:33:10
DeviceCore #0: NEWTEKNDIHXPTZ0, IP = 192.168.10.213
ClientVISCAoverIP fixedSrcPort:0
setup() Done
-----
HWc#2 Down Speed: 0
System action 17
System action 15
System action 17
System action 17
VISCAbase: Connection to cam 2 established, pulling status
Received block command 0 for camera 2
HWc#3 Down Speed: 0
VISCAbase: Connection to cam 1 established, pulling status
Received block command 0 for camera 1
Received block command 1 for camera 2
Received block command 1 for camera 1
Received block command 2 for camera 2
Received block command 2 for camera 1
Received block command 3 for camera 2
Received block command 3 for camera 1
61
.89
.Status received from camera 2!
Status received from camera 1!
89
.89
.89
```

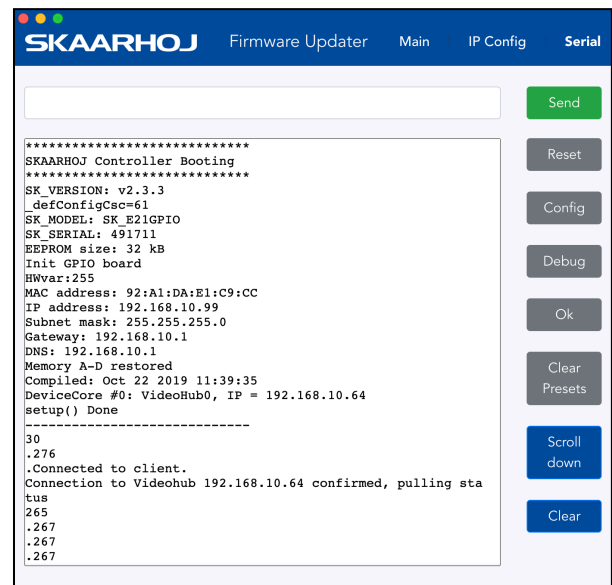

```
SKAARHOJ Firmware Updater Main IP Config Serial
Send
Reset
Config
Debug
Ok
Clear Presets
Scroll down
Clear

*****
SKAARHOJ Controller Booting
*****
SK_VERSION: v2.3.3
_defConfigCsc=61
SK_MODEL: SK_E21GPIO
SK_SERIAL: 491711
EEPROM size: 32 kB
Init GPIO board
HWvar:255
MAC address: 92:A1:DA:E1:C9:CC
IP address: 192.168.10.99
Subnet mask: 255.255.255.0
Gateway: 192.168.10.1
DNS: 192.168.10.1
Memory A-D restored
Compiled: Oct 22 2019 11:39:35
DeviceCore #0: VideoHub0, IP = 192.168.10.64
setup() Done
-----
30
.276
.Connected to client.
Connection to Videohub 192.168.10.64 confirmed, pulling sta
tus
265
.267
.267
.267
```

Setting IP for Controllers with Stand alone Firmware

For non UniSketch OS controllers the procedure for setting IP address differs:

ATEM-TCP Link

The ATEM-TCP Link is exceptional in the procedure for setting IP address and in operation. This is done via the Serial Monitor. Please see instructions at <https://www.skaarhoj.com/products/atem-tcp-link/>. The Device does not have a web server like otherwise found on controllers with stand alone firmware.

Refrain from using "Update Firmware" in the Firmware Application as this will render the firmware on the device useless. If "Update Firmware" have been pressed, please re-upload the proper firmware .hex file found in the section "Stand Alone Firmwares" from <https://www.skaarhoj.com/support/firmware-updater/>

ETH-SDI Link and ETH-LANC Link

Setting the IP address on the ETH-SDI Link and ETH-LANC Link is done from the web server locally on the device itself. In order to access the web server two things must be done:

- Set static IP address on your computer
- Enable the web server on the device it self by putting it in Config Mode

Refrain from using "Update Firmware" in the Firmware Application as this will render the firmware on the device useless. If "Update Firmware" have been pressed, please re-upload the proper firmware .hex file found in the section "Stand Alone Firmwares" from <https://www.skaarhoj.com/support/firmware-updater/>

Set manual IP address for Mac/PC

We recommend connecting the device directly to your computer with a ethernet cable in order to access the web interface A fixed IP address with the same subnet as the device must be set on your computer

Turn off your wifi and set your IP manually:

IP Address: 192.168.10.50
Subnet: 255.255.255.00
Gateway: 192.168.10.1

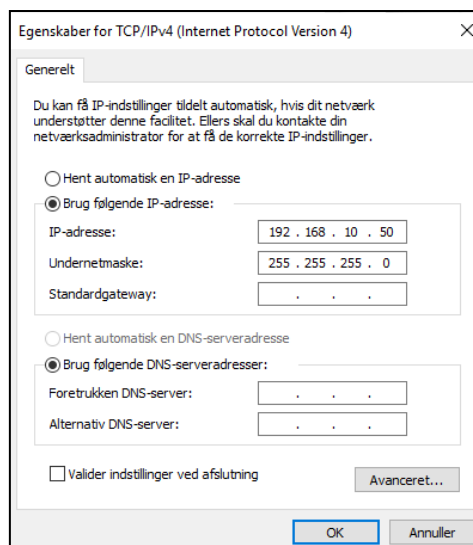
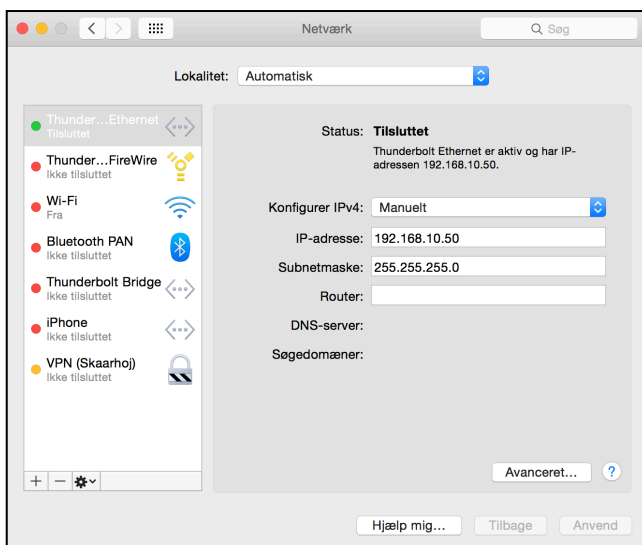

Enable webserver

- **Step 1** – Connect device to computer with ethernet cable and power up the unit. Let it boot up.
- **Step 2** – Press and hold the config button until the status LED starts to blink to enable Config Mode
- **Step 3** – Access web interface by entering `http://192.168.10.99/` in your browser



Location of "Config" and "Status LED"

SKAARHOJ

SKAARHOJ Device IP Settings:

IP: 192 . 168 . 10 . 99
Subnet: 255 . 255 . 255 . 0
Gateway: 192 . 168 . 10 . 1

ATEM IP: 192 . 168 . 10 . 240

(Reset / Pull the power after submitting the form successfully)

Notice: The web interface IP is always set to `http://192.168.10.99` even if you change the "SKAARHOJ Device IP Address" in the web interface.

If you have the serial monitor open while enabling the web server you will often see a message to confirm that config mode is enabled.

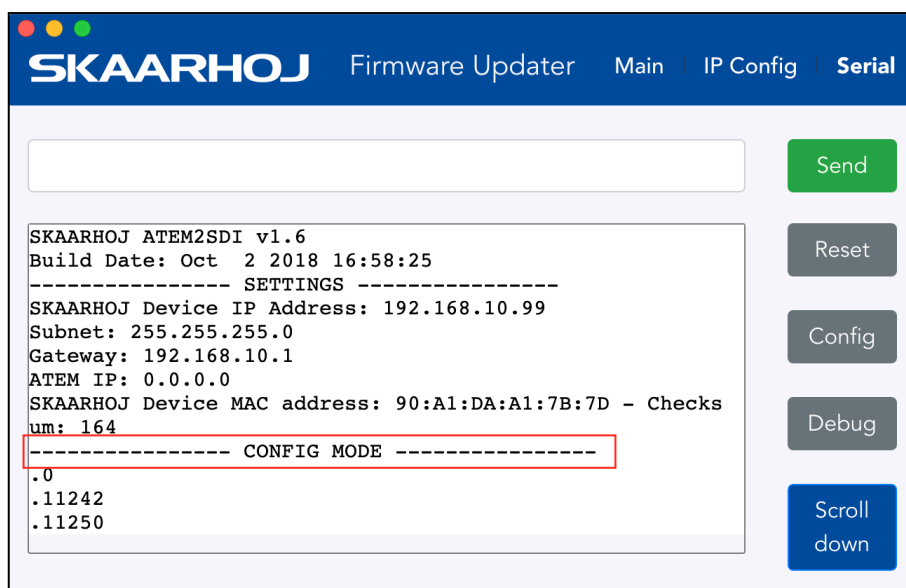

UniSketch OS

A SKAARHOJ controller running UniSketch OS has a license profile in our online repo at cores.skaarhoj.com. This is where its software (firmware) came from that was programmed onto the unit when it was delivered. Whenever you need a firmware upgrade for whatever reason, this is where the firmware will be downloaded from by the Firmware Application. But this is only the most basic case. cores.skaarhoj.com provides you a fantastic way to expand the features of your controller; you can select between different pre-made configurations, install new device cores (support for more broadcast hardware), change configuration of the controllers behaviour, add media strings and graphics and manage multiple configurations for your controller. Please see the training videos at: <https://www.skaarhoj.com/support/manuals/>

To access the Configuration Page for your controller, simply connect it by USB to your computer and start the SKAARHOJ Firmware Application, then press "Online Configuration". A web browser will open and take you to the configuration page on cores.skaarhoj.com. Whenever you are done changing the configuration online, return to the SKAARHOJ Firmware App and press "Update Firmware". A new firmware reflecting the changes will be created and downloaded to your controller.

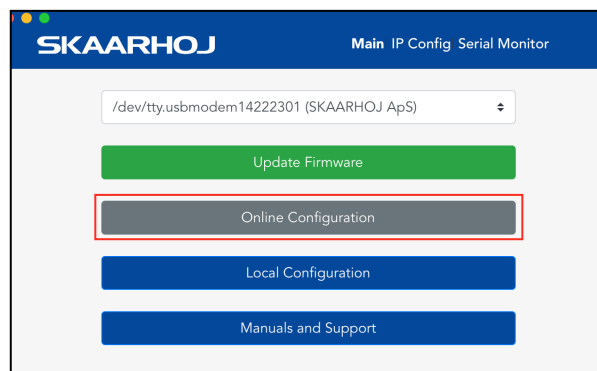

By default the configuration page will look something like this. Here you can select between different pre-made configurations and read a short description. You can also change Network settings and set IP address for Device Cores. If you press the red "Advanced" button you will access a configuration page where you can tweak an existing configuration or build one for yourself!

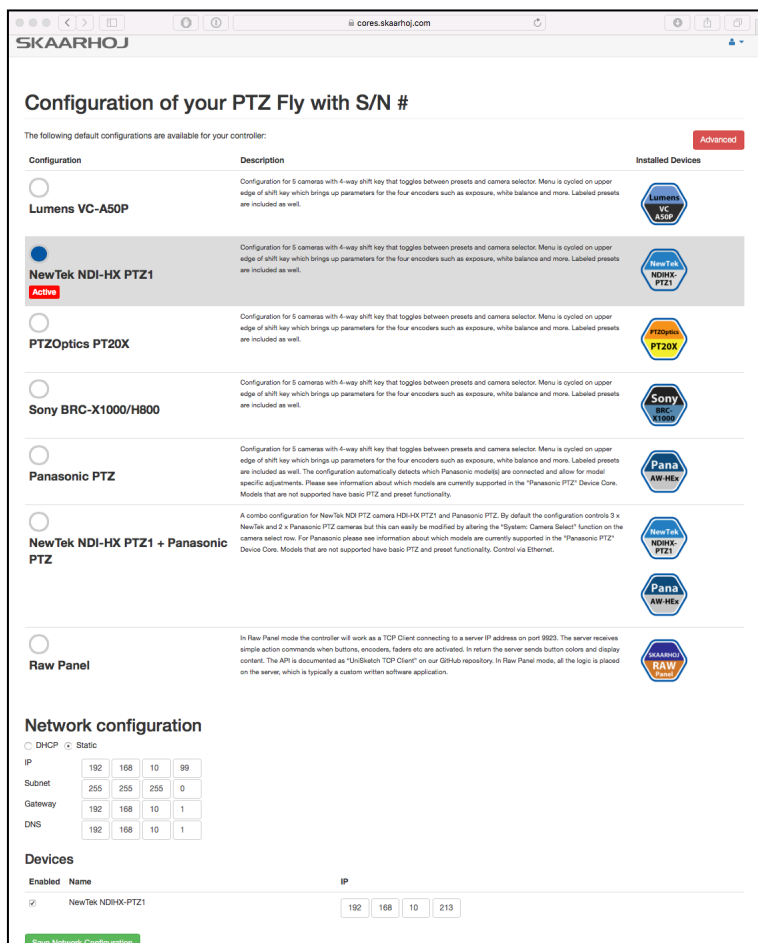

Advanced Configuration

This is where the fun begins! On the advanced configuration page you can tweak the configuration or make one for yourself. The configuration you set up here will become the default configuration of your controller with the next firmware download. When pressing a hardware interface component the configuration will jump to that component and you can modify or change the actions. Please see the training videos at: <https://www.skaarhoj.com/support/manuals/>

Chose a configuration from the drop down menu, copy or start with a clean slate

Set IP addresses at the bottom of the page

Device Cores

Add or remove Device Cores on the "Device Core" tab.

Manage Configurations

Select either SKAARHOJ official configuration from this tab or manage your User Configurations by assigning names, descriptions or delete. You can even Share a configuration to another controller with the "Share Button". This creates a ID number which you subscribe to in the "Configuration Subscriptions" section.

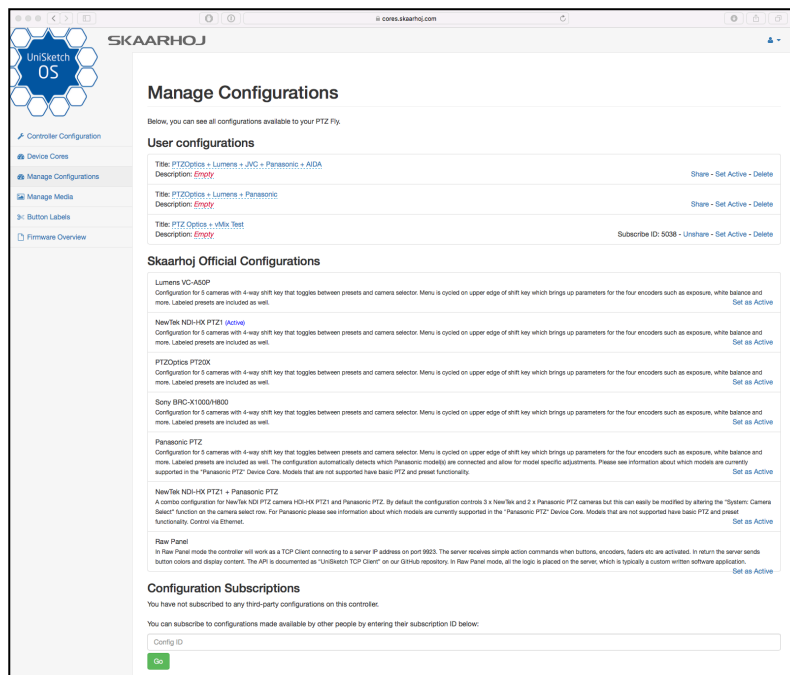

Manage Media

Add strings or images to your configuration. Device Core options are also set on this tab.

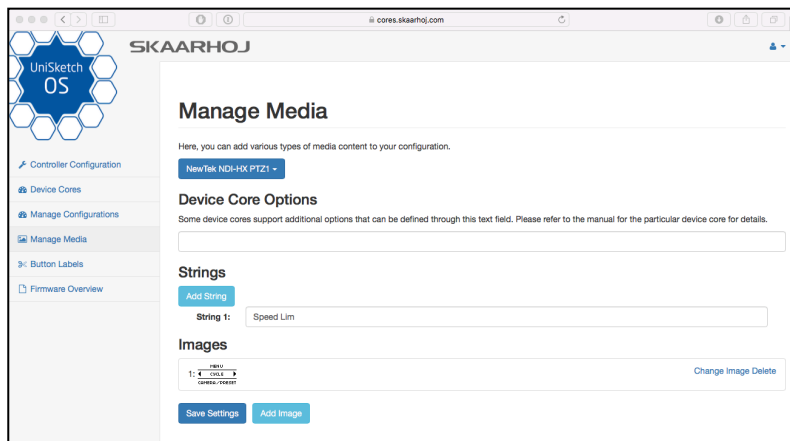

Firmware Overview

Download or generate a new firmware file - use it for archiving or field-update purposes.

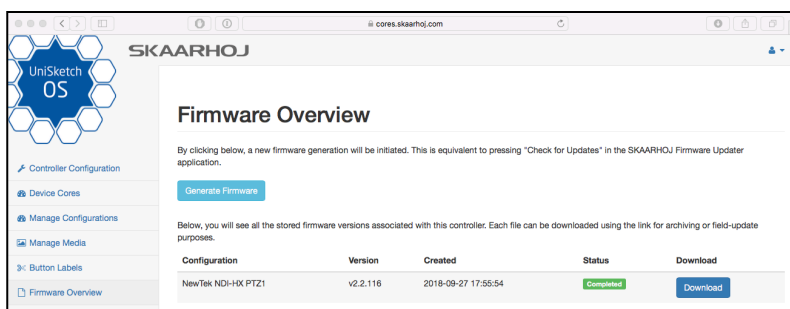

Device Core Options

For some Device Cores a "Device Core Options" can be found. See the specific Device Core manuals for instructions on how to set these.

Notice if you want to set Device Core options for several Device Cores the structure is as following

$Dx:y=z;Dx:y=z$

Setting several Device Core Option indexes for the same Device Core is as following

$Dx:y=z,y=z$

Where the general form would be "Dx:y=z" where "x" is the number of the device cores installed on the controller (starting with zero for the first device core), "y" the index number and "z" the value for that index.

Device Cores

External hardware support is made available on your controller as what we call Device Cores. A device core is the driver - or akin to an "app" - installed on the your controller that enables communication support with a given piece of broadcast gear. Some are very mature and full featured, others still just basic, some are in beta versions and yet others are just planned at this stage



You can always see the latest status here www.skaarhoj.com/support/device-cores/ and find specific Device Core manuals www.skaarhoj.com/support/manuals if they exist. For most Device Cores communication is direct via IP, however for some it is via a Serial Converter Box. If this is the case it will be noted in the Device Core manual.

vMix Device Core

When using our controller together with vMix the application vMixBridge is necessary to run on your computer. This gabs communication between our controller and vMix - get it here: www.skaarhoj.com/support/device-cores/vmix/ and remember to check specifics in the vMix Device Core manual at www.skaarhoj.com/support/manuals

Firmware Updater Application

A quick introduction to the Firmware Updater Application is presented in the “Getting Started” section. Here we provide some more details. The applications can be downloaded for your computer at: www.skaarhoj.com/support/firmware-updater/



A beta version of the Firmware Updater Application is available on www.skaarhoj.com/support/firmware-updater/. The principles between the application and the beta application are very similar. Illustrations in this manual are based on the beta version.



Notice the button “Check for Updates” have been renamed to “Update Firmware”. We are in the process of updating relevant images to reflect this.

When the application is installed and open, connect your controller with USB to the computer. It should now be displayed in the “Port” dropdown box. Please only connect *one* SKAARHOJ controller at a time.



A number of options now exist.

- **Update Firmware:** Generates a new firmware on our server and downloads it to the unit. This is required whenever a change to the configuration has been made from “Online Configuration”, or we have updated UniSketch OS and Device Cores.
- **Online Configuration:** Opens a web browser and gives you access to the online configuration page of your controller. Remember a change made here is not saved on the controller before “Update Firmware” is pressed. Your computer must be connected to the internet.
- **Local Configuration:** Starts a local web server on the controller and opens a web browser with a local configuration page. Make sure your computer is on the same network as the controller. Please notice changes made in the local configuration will *not* be synced with your Online Configuration unless synced to the server. If the local config is not synced and “Update Firmware” command is executed the Local Configuration will be overwritten!
- **IP Configuration:** Displays the configuration window for IP settings on the controller and Device Cores.
- **Serial:** Displays the Serial Monitor for the controller. Useful for debugging and gathering additional information from the controller.

Update Firmware

When the "Update Firmware" is pressed the following is happening

- **Firmware Generation:** A firmware unique to your controller with selected functionality and Device Cores will be compiled on our server. This is equivalent to pressing "Generate Firmware" on the **Firmware Overview tab** on the configuration page.
- **Installation of Firmware:** Once the firmware have been generated it will be downloaded and installed onto the controller

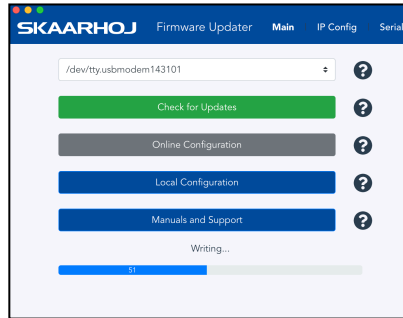
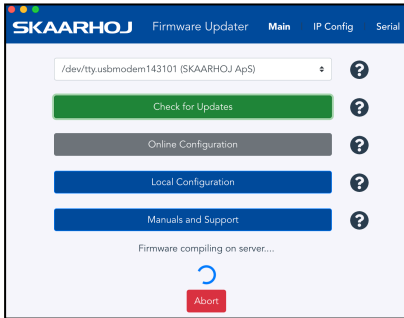

It is recommend to use "Update Firmware" if the controller is unresponsive. This includes if "Online Configuration" and "Local Configuration" is not working. However please try and power cycle the controller first



Firmware files have a unique hardware ID, and a firmware file generate on one controller will not function on any other hardware device. If interested in sharing a configuration please see "Manage Configurations"

Online Configuration

When the "Online Configuration" is pressed the following is happening

- **Acquire unique hardware ID:** The application will fetch the unique hardware ID (also called a CID number) from the controller. If this is troublesome please try and power cycle the controller. Alternatively try and press "Update Firmware" to restore the firmware back to normal on the unit.
- **Open Configuration Page:** The default browser on your computer will open the Configuration Page of the controller. This requires internet access. On this page you can select among any of our Default Configurations including saving network settings our you can create your own configuration. Please make sure a default browser is set and please notice that the Configuration page heavily depends on modern JavaScript and may malfunction with older browsers. We suggest the use of Google Chrome.

The direct URL to the Configuration Page is: <http://cores.skaarhoj.com/?CID=CID Number here>

The CID number can be acquired from the Serial Monitor via the command: getCID or via a shortcut in the Firmware Application.

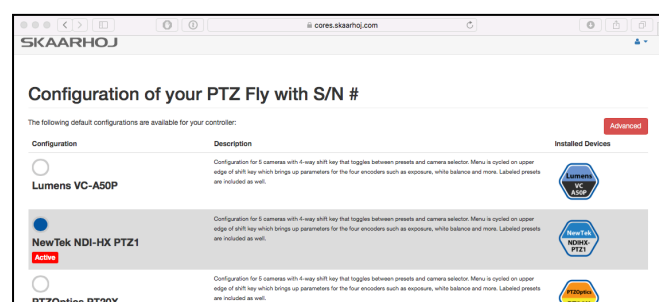

Local Configuration

When the "Local Configuration" is pressed the following is happening

- **Starts/Stop local web server:** A web server on the device itself will start/stop depending on current state. This is equivalent to write: webconfig in the serial monitor. The local web server will have the IP of the controller itself set either via the Firmware on the unit or via "IP Configuration" tab in the Firmware Application.
- **Open Local Configuration Page:** The default browser on your computer will open the Local Configuration Page of the controller. Please make sure your computer is on the same network as the controller. Please make sure a default browser is set and please notice that the Configuration page heavily depends on modern JavaScript and may malfunction with older browsers. We suggest the use of Google Chrome.

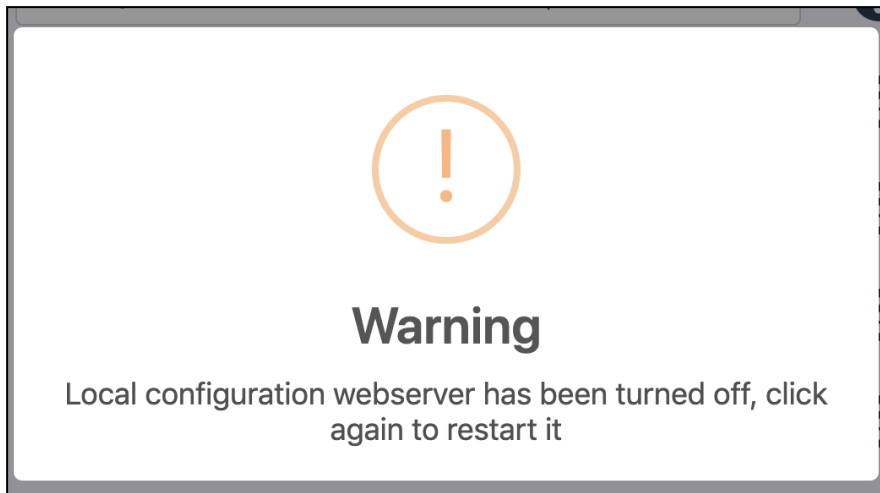

By default the local webservice is not enabled. This must be activated via the "Local Configuration" button or via webconfig in the serial monitor. The local webservice can be enabled by default. Please see the section "Enable Local Configuration by default"

IP Config

The IP Config tab will provide an overview of the IP settings of the controller itself and IP addresses of Device Cores.



The screenshot shows the 'IP Configuration' tab in the SKAARHOJ Firmware Updater. The interface includes a navigation bar with 'Main', 'IP Config', and 'Serial' tabs. The main content area is titled 'IP Configuration' and contains the following settings:

- Use DHCP: Enable
- IP Address: 192.168.10.240 ✓
- Subnet Mask: 255.255.255.0 ✓
- Gateway: 192.168.10.1 ✓
- DNS Server: 192.168.10.1 ✓

Below the IP Configuration section is the 'Device Cores' section, which includes:

- BMD ATEM: 192.168.10.240 ✓ Enable

At the bottom of the form are 'Cancel' and 'Save Settings' buttons.

Network settings can also be confirmed from the boot up state of the controller in the Serial Monitor:

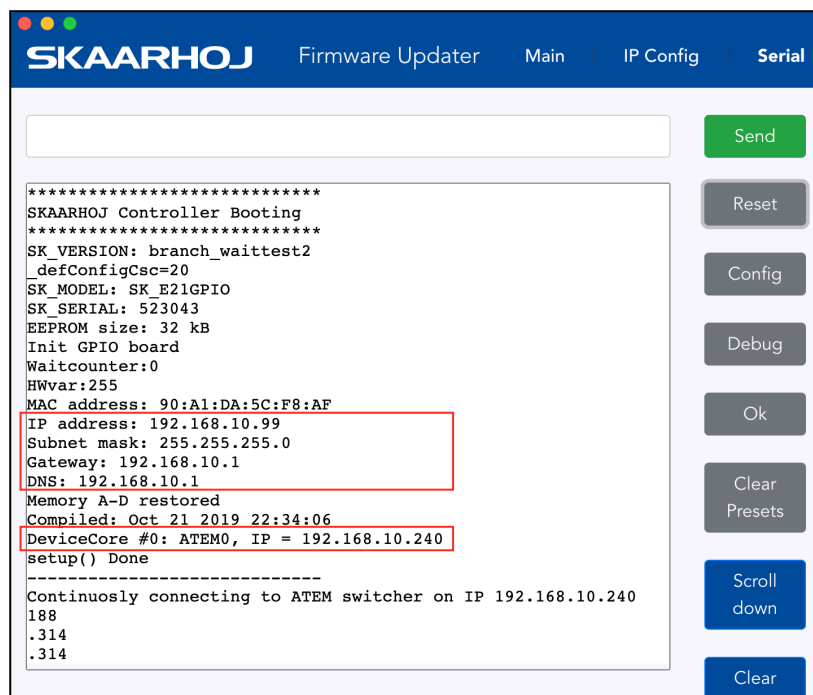

The screenshot shows the 'Serial Monitor' tab in the SKAARHOJ Firmware Updater. The interface includes a navigation bar with 'Main', 'IP Config', and 'Serial' tabs. The main content area displays the boot logs of the controller, with several lines highlighted in red:

```
*****
SKAARHOJ Controller Booting
*****
SK_VERSION: branch_waittest2
_defConfigCsc=20
SK_MODEL: SK_E21GPIO
SK_SERIAL: 523043
EEPROM size: 32 kB
Init GPIO board
Waitcounter:0
HWvar:255
MAC address: 90:A1:DA:5C:F8:AF
IP address: 192.168.10.99
Subnet mask: 255.255.255.0
Gateway: 192.168.10.1
DNS: 192.168.10.1
Memory A-D restored
Compiled: Oct 21 2019 22:34:06
DeviceCore #0: ATEM0, IP = 192.168.10.240
setup() Done
-----
Continuosly connecting to ATEM switcher on IP 192.168.10.240
188
.314
.314
```

On the right side of the Serial Monitor, there are several control buttons: 'Send', 'Reset', 'Config', 'Debug', 'Ok', 'Clear Presets', 'Scroll down', and 'Clear'.



Please notice if changing the IP address via "IP Config" a local preset is created on the controller and the IP will no longer match any IP settings set via "Online Configuration". The local preset will overrule IP settings from "Online Configuration". This is explained further in the next section "Methods of Settings IP Addresses"

Methods of Setting IP Addresses

Two methods exist to set IP settings on the Device Cores and the controller itself.

- **Method 1:** Using "Online Configuration" and "Update Firmware" in the Firmware Application

Setting IP for default Configurations

If no custom configurations have been made on a SKAARHOJ controller, an overview with default configurations will appear when pressing "Online Configuration"

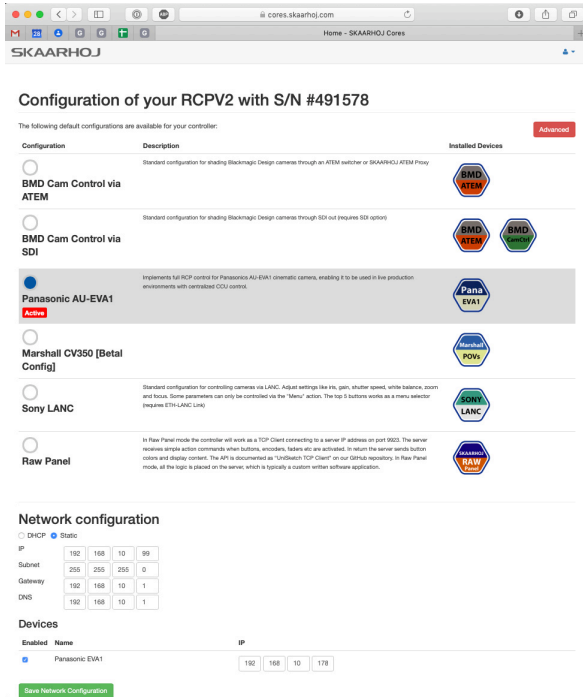

In the section "Network configuration" you can set the desired IP addresses. Press "Save Network Configuration" and then press "Update Firmware" in the Firmware Application.

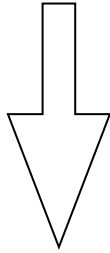

Setting IP for custom configurations

If custom configurations have been made on a SKAARHOJ controller a overview like below will appear when pressing "Online Configuration"

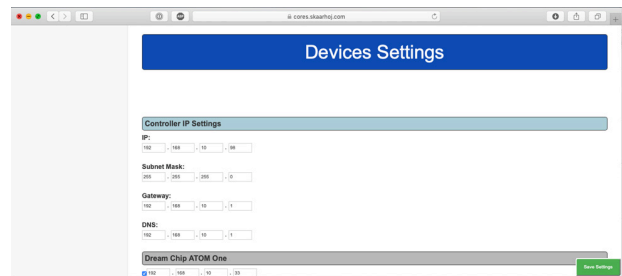

At the bottom of the config page you set IP settings. Remember to press "Save Settings" and then press "Update Firmware" in the Firmware Application.

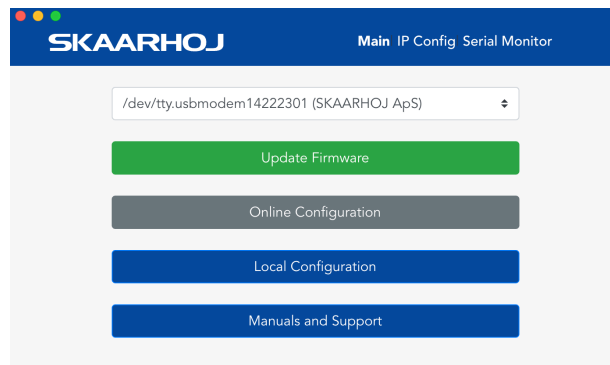

Press "Update Firmware"

- **Method 2:** Using "IP Configuration" in the Firmware Application

A alternative way of setting IP addresses is using the "IP Configuration" option in the Firmware Application

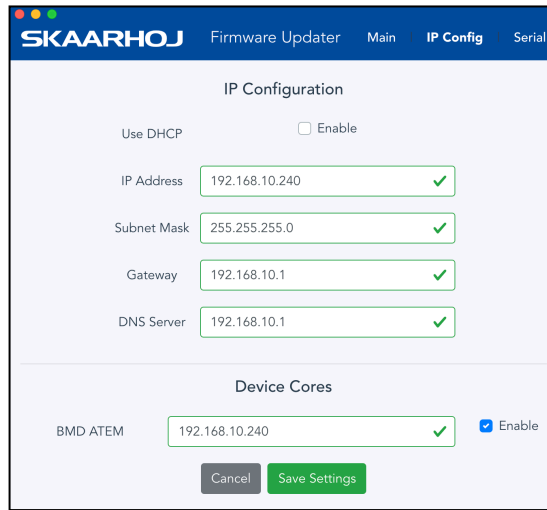

Please notice this will generate a local "preset" on the controller. This preset will **override** IP settings set in the "Network Configuration/Device Settings" on the Configuration page when pressing "Update Firmware" **unless:**

- One have opened the config page with default configurations and pressed "Save Network Configuration" and then pressed "Update Firmware"
- One have opened the config page with custom configurations and pressed "Save Settings" and then pressed "Update Firmware"



The Serial Monitor can be used to monitor if a "Preset" exist

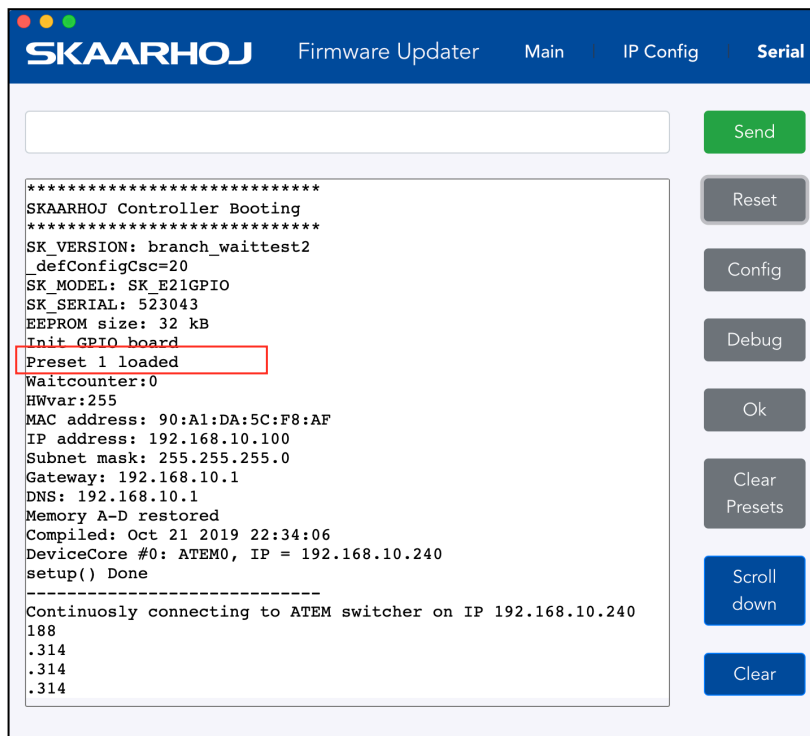

A preset can be deleted by using the above methods (Save Network Configuration or Save Settings and then pressing "Update Firmware"). Alternatively press "Clear Presets" in the Serial Monitor.

Static IP or DHCP

A UniSketch OS controller will have the IP you set on the configuration page or via the "IP Configuration" tab in the Firmware Application. Please see details in the previous section. During your boot up process you can always confirm the IP settings on the controller and the Device Cores.

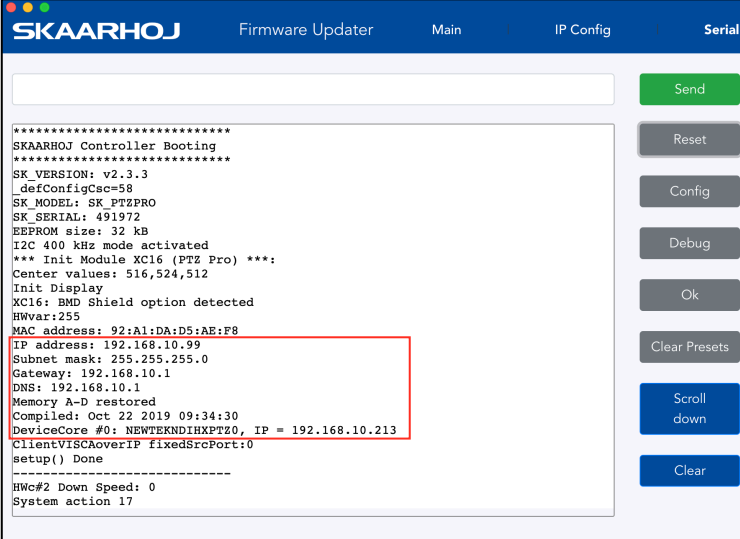

```
SKAARHOJ Controller Booting
*****
SK VERSION: v2.3.3
_defConfigCsc=59
SK_MODEL: SK_PTZPRO
SK_SERIAL: 491972
EEPROM size: 32 kB
I2C 400 kHz mode activated
*** Init Module XC16 (PTZ Pro) ***:
Center values: 516,524,512
Init Display
XC16: BMD Shield option detected
HWvar:255
MAC address: 92:A1:DA:D5:AE:F8
IP address: 192.168.10.99
Subnet mask: 255.255.255.0
Gateway: 192.168.10.1
DNS: 192.168.10.1
Memory A-D restored
Compiled: Oct 22 2019 09:34:30
DeviceCore #0: NEWTEKNDIHXP20, IP = 192.168.10.213
ClientVISCAoverIP fixedSrcPort:0
setup() Done
-----
HwC#2 Down Speed: 0
System action 17
```

If the controller's IP is set to 0.0.0.0 (four zeros) or DHCP is set on the configuration page/in the IP Config tab the controller will get a IP address from your DHCP server on your network.

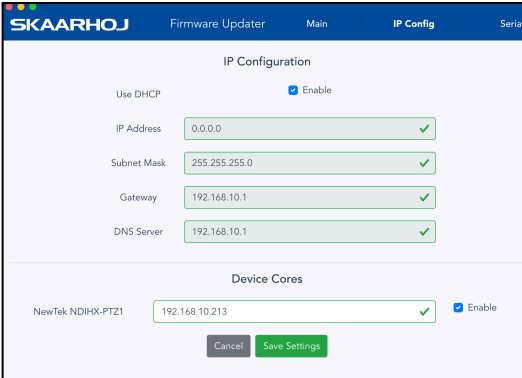

IP Configuration

Use DHCP Enable

IP Address: 0.0.0.0 ✓

Subnet Mask: 255.255.255.0 ✓

Gateway: 192.168.10.1 ✓

DNS Server: 192.168.10.1 ✓

Device Cores

NewTek NDihX-PTZ1: 192.168.10.213 ✓ Enable

Cancel Save Settings

A message with "Requesting DHCP address... OK" will appear in the serial monitor if the controller gets a IP address from the DHCP server.



```
SKAARHOJ Controller Booting
*****
SK VERSION: v2.3.3
_defConfigCsc=59
SK_MODEL: SK_PTZPRO
SK_SERIAL: 491972
EEPROM size: 32 kB
I2C 400 kHz mode activated
*** Init Module XC16 (PTZ Pro) ***:
Center values: 516,524,512
Init Display
XC16: BMD Shield option detected
HWvar:255
MAC address: 92:A1:DA:D5:AE:F8
Requesting DHCP address... OK
IP address: 192.168.10.173
Subnet mask: 255.255.255.0
Gateway: 192.168.10.1
DNS: 192.168.10.1
Memory A-D restored
Compiled: Oct 22 2019 09:43:34
DeviceCore #0: NEWTEKNDIHXP20, IP = 192.168.10.213
ClientVISCAoverIP fixedSrcPort:0
setup() Done
-----
HwC#2 Down Speed: 0
```

If the controller is not assigned with a IP address from DHCP during boot up the serial monitor will report "Requesting DHCP address... failed" and the controller will fall back to IP address 0.0.0.0

```
Requesting DHCP address... failed
IP address: 0.0.0.0
Subnet mask: 0.0.0.0
Gateway: 0.0.0.0
DNS: 0.0.0.1
```

The controller will continuously try to get a IP address from the DHCP server. If successfully the message "DHCP Renewed: x.x.x.x" will appear.

```
.DHCP Renewed: 192.168.10.173
```

Serial Monitor

The serial monitor in the Firmware Application is an indispensable tool for bug fixing any problems with your SKAARHOJ controller. The serial monitor runs at 115200 baud and a typical output from the boot process looks like this:

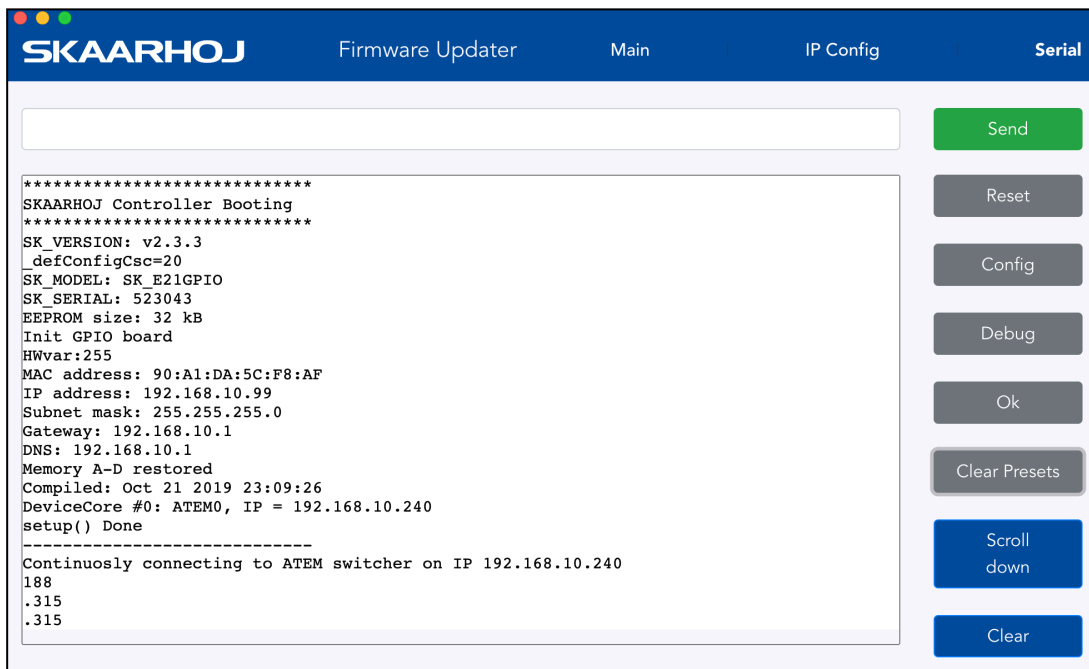

The screenshot shows the SKAARHOJ web interface with the 'Serial' tab selected. The main area displays the following boot logs:

```
*****  
SKAARHOJ Controller Booting  
*****  
SK_VERSION: v2.3.3  
_defConfigCsc=20  
SK_MODEL: SK_E21GPIO  
SK_SERIAL: 523043  
EEPROM size: 32 kB  
Init GPIO board  
HWvar:255  
MAC address: 90:A1:DA:5C:F8:AF  
IP address: 192.168.10.99  
Subnet mask: 255.255.255.0  
Gateway: 192.168.10.1  
DNS: 192.168.10.1  
Memory A-D restored  
Compiled: Oct 21 2019 23:09:26  
DeviceCore #0: ATEM0, IP = 192.168.10.240  
setup() Done  
-----  
Continuously connecting to ATEM switcher on IP 192.168.10.240  
188  
.315  
.315
```

On the right side of the interface, there are several control buttons: Send (green), Reset, Config, Debug, Ok, Clear Presets, Scroll down (blue), and Clear (blue). At the top, there are navigation tabs for Firmware Updater, Main, IP Config, and Serial.

This tells us the firmware version loaded, model name of the controller, serial number, how a number of hardware components have been initialized, which IP address, subnet mask and MAC address the controller has, which date the software was compiled. It also shows us which hardware devices it will try to connect to. During this process until the "setup() Done" message is output, the status LED will blink purple.

After the setup, the controller enters normal operational state. You see that it tries to connect to the devices and that it succeeds in this. During this process, the status LED blinks yellow and eventually it will blink green.

The serial monitor will continuously output a small dot and a number every second. If this is not the case permanently, it indicates a crash of the controller. The number indicates the number of times a second the controller manages to check all device connections and hardware components. It should be higher than 25. The higher the better. This number may/will drop if there are problems, if something slows down the controller, if devices are not connected properly or in the process of being connected, if a lot of displays needs to be updated etc. The lower this value, the less responsive the interface will feel. This value will also be impacted by the number and type of actions configured for interface components in the web interface. Network problems may also impact this value. If this value is too low, the controller may further loose connections to devices and may seem unresponsive to interface operations.

Commands in the Serial Monitor

You can enter commands in the serial monitor to do certain things with the controller. This is particularly useful for developers and also for bug-fixing and calibration.

"config"	Reboots the device into config mode with its current IP. Similar to holding the config button until the LED becomes blue.
"configd"	Reboots the device into config default mode (IP always 192.168.10.99). Similar to holding the config button until the LED becomes white.
"debug"	Reboots and enables debug output to serial monitor
"sockets"	Lists the 8 available sockets and their status. (If "debug" mode is enabled - see above - whenever a change happens to a socket you will see it printed in the serial monitor on the same form)
"newmac"	Generates a new random MAC address to EEPROM. Power cycle both your controller and network switch after this operation. Useful if you have network problems.
"clearpresets"	Clears the preset memory completely (flushes all!). Useful/necessary after a firmware upgrade. Similar to holding the config button until the LED becomes red.
"reset"	Reboots the controller
"HWvar=XXX"	Set Hardware Variant (byte). This value shouldn't be changed by users. It's significance is to inform the UniSketch software about which hardware revision it's running on in order to take certain specifics into account. Bit 0: Determines model of status LED on SKAARDUINO-AVR models.
"list analog"	Lists analog hardware components on the controller with number, description and three calibration values (start/end/tolerance)
"show analog X"	Shows readings from analog component X where X is the number given by "list analog". The readings indicate the value and noise level for the read out. This is useful for debugging. If you move the analog component you should see values change. Write "hide analog" to stop the display.
"hide analog"	Stops the display of "show analog"
"calibrate analog X"	Starts calibration of analog component X. Instructions will be posted in the serial monitor. The steps involve moving the analog component to various positions.
"clear analog X"	Resets calibration data for analog component X to default. If X is not given it resets calibration data for all components.
"set analog X=start,end,tolerance"	Forces calibration data "start", "end", and "tolerance" for component X
"show joystickDeadzone"	Shows joystick deadzone values if they have been set via "joystickDeadzone=X,Y,Z" (see below)
"joystickDeadzone=X,Y,Z"	Set deadzone values for a joystick component X = Pan deadzone in percentage Y = Tilt deadzone in percentage Z = Zoom deadzone in percentage Default values are 20%. Applicable values are between 1% and 100% Example: "joystickDeadzone=5,10,20" equals 5% pan, 10% tilt and 20% zoom deadzone
"exportPresets"	Will dump a large amount of data representing the entire configuration with presets in the controller. Last two bytes is a checksum
"importPresets"	Will import configuration into the internal EEPROM memory. After sending the command, the controller will instruct to paste configuration into the serial monitor. It must be formatted like the output from "exportPresets"
"preset X"	Will select the given preset number X if it exists and reboot the controller
"ip=A.B.C.D"	Sets the controller IP address (for the current preset)
"ipDeviceX=A.B.C.D"	Sets the IP address for device index X (see boot up output) for the current preset.
"enableDeviceX=[0/1]"	Enable or disable device X for the current preset.
"clearusermemory"	Clears user memory space (used for various types of device setting presets).
"getVersion"	Shows the current version of UniSketch
"getCID"	Returns the controllers unique ID, which is used to access the configuration pages on cores.skaarhoj.com . Since this ID gives access to the online configuration, do not share it publicly.

Technical Notice: Any operation from the serial monitor that reboots the controller, does so with a "soft" reset and the Ethernet chip in the controller may still hold old settings. In most cases this is no problem, but at other times it may lead to strange behaviors and connection problems. In that case; power cycle the unit,



press the reset button shortly or close down and reopen the serial monitor which will also act as a hardware reset.

Load Firmware from File

The function "Load Firmware from File" is in the Options tab in the Firmware Application. The function is used to:

- **Load Firmwares generated from "Firmware Overview:** If a Firmware have been generated for field updating or achieve purposes.
- **Load Firmwares for Stand Alone Units:** Loading/updating firmware for Stand Alone units such as the ATEM-TCP Link, ETH-SDI Link or ETH-LANC Link.



Firmware files have a unique hardware ID, and a firmware file generate on one controller will not function on any other hardware device. If interested in sharing a configuration please see "Manage Configurations"



On Mac

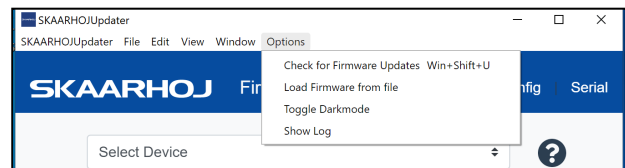

On PC

Expert Mode

By enabling "Expert Mode" three new features are made available

- **Update Firmware from Master:** Will generate a firmware from what we call Master instead of a released firmware version. Would typically be used if instructed to do so by developers or support.
- **Update Firmware from Branch:** A popup windows will appear where:
 - A branch name can be put in. Would typically come from developers/support
 - A version number. If you want to generate a firmware on your controller from a specific firmware version. Example "v.2.4.5"
- **Update Firmware without Recompilation:** Will pull the last firmware generated for the controller without needing to recompile. Would typically be used if the firmware was generated earlier to save time or if the firmware currently on the controller became corrupted.
- **Online Configuration (Staging):** Firmwares generated from either Master or Branch will do so from the Online Configuration called Staging.

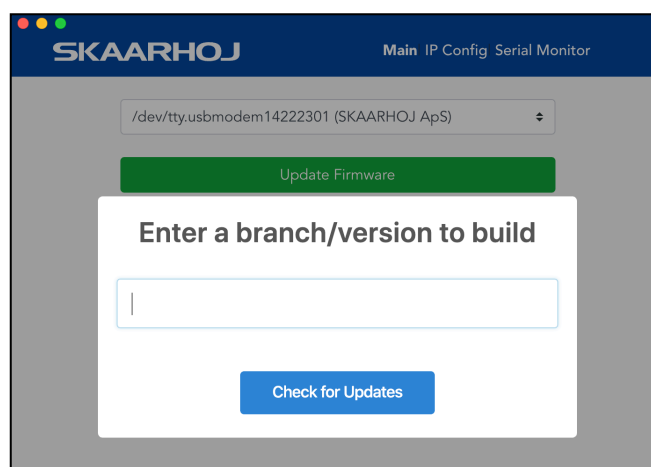
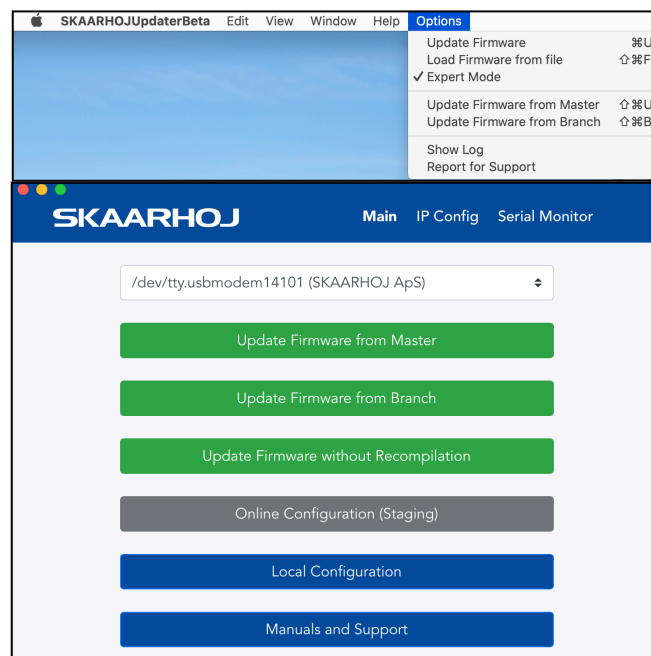

Shortcuts

A number of shortcuts are available in the Firmware Updater Application

Update Firmware

Mac: command+u

Windows: ctrl+u

Compile from Master

Mac: shift + command + u

Windows: shift + ctrl + u

Compile from branch

Mac: shift + command + b

Windows: ctrl + shift + b

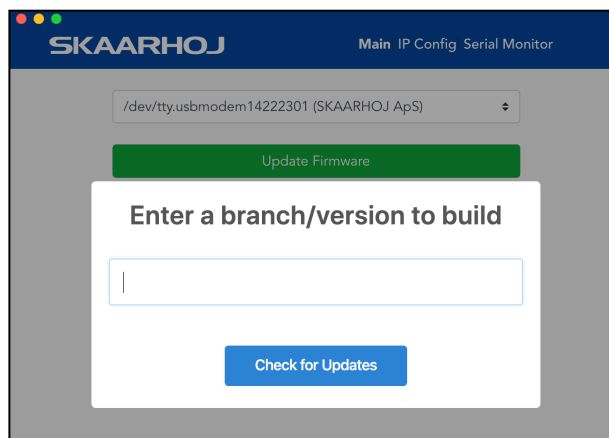

Retrieve and get the CID

Mac: Shift + command + c

Windows: shift + ctrl + c

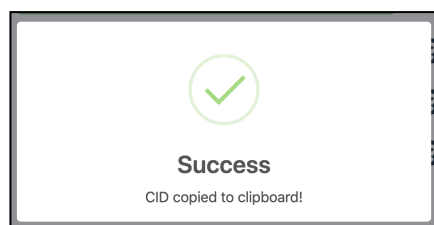

Open Serial Monitor

Mac: Shift + command + m

Windows: Shift + ctrl + m

Uploading Error

If the update process for whatever reason is interrupted (e.g. power loss) the firmware will be rendered useless on your device. A new firmware have to be uploaded to the unit.

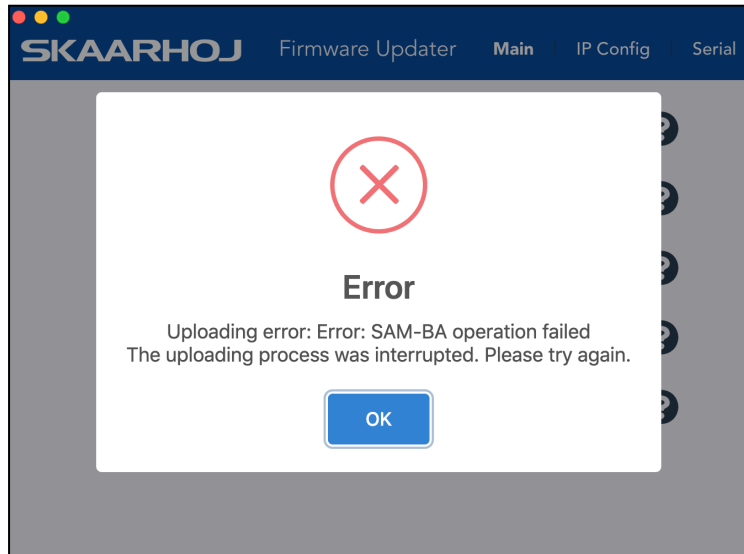

Press "Update Firmware" - you will be presented with a message about a "An intermediate software version...". Press "OK" to proceed. A intermediate firmware will be loaded on your unit, and subsequently the final firmware.

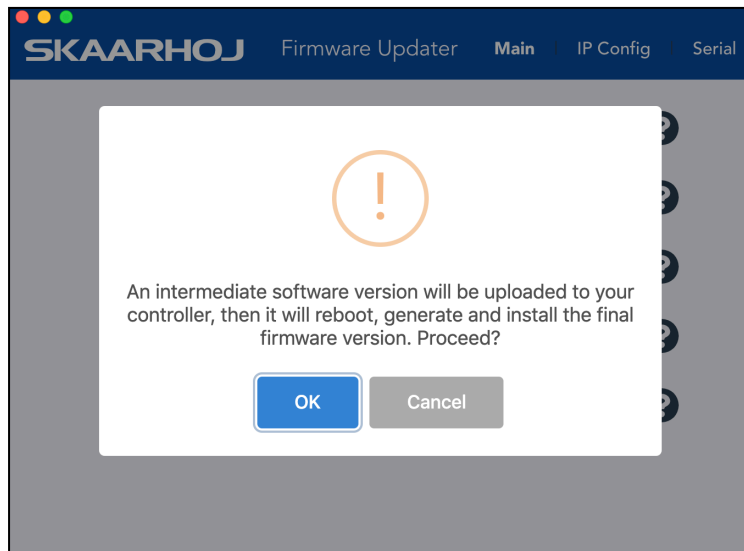

Error on Check: Your controller is not yet registered

In rare cases you might experience a message from the Firmware Updater stating that the connected controller is not fully registered yet. This happens if the unique hardware ID of your controller does not match the record in our database.

In order to solve this issue please send the following information to support@skaarhoj.com

- Identification code from the Firmware Application.
- Serial number of the unit. The serial number is found on a small silver sticker with 6 digits.

If you press the email link in the error message a email will subject line including the CID number will be created. After we have confirmed the registration by email press "Update Firmware" in the Firmware Application. This will render a new valid firmware for your device.

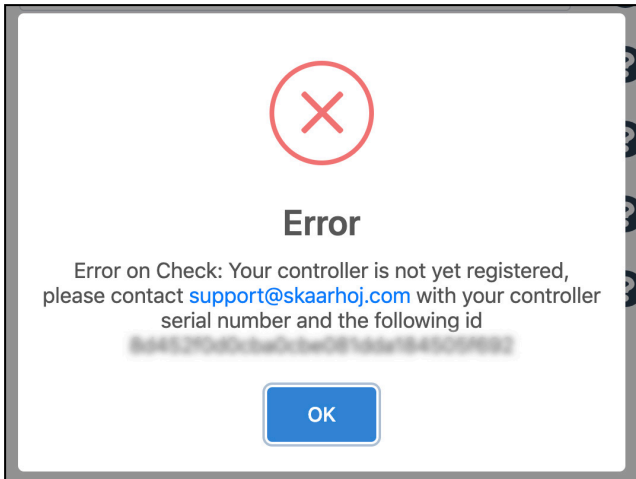

Network Recommendations

Facts

- SKAARHOJ controllers have a 100 mbps network interface
- Network switch must have Auto-MDI/MDIX
- Network switch must support 100 mbps
- PoE: IEEE 802.3af
- SKAARHOJ controllers only support Half Duplex mode without Auto-Negotiate

When connected to a network switch, the yellow LED (lower left) at the ethernet jack will be on. If the device in the other end supports TX/RX auto detection you may be able to connect the SKAARHOJ controller directly to your device, otherwise use a crossed cable or a network switch (the supported setup). Remember a SKAARHOJ controller and client must be on the same subnet (192.168.10.* or one you set up in the controller). If you have multiple SKAARHOJ units connected to the same network they need to have different IP addresses!

Power over Ethernet (PoE) Specifications

We use the PoE industry standard 48V IEEE 802.3af. If you want to power our controllers using PoE it is important your switch supports this standard. Please notice some manufactures such as Ubiquity have their own non-standard 24V type of PoE which is incompatible with our controllers. Especially pay attention to the standard if you use a PoE injector.

Troubleshooting

If you experience no network activity at all try one or more of the following suggestions:

- Use a managed network switch
- Force network switch port to 100 mbps
- Try a different network switch

1GB or 10 GB switches can have issues with our 100 mbps interface if not properly managed. The iMac Pro with 10 GB have issues if connected directly to our controller. Try with a USB to ethernet adapter in this case.

Connection Stability and NDI

Background: People are moving to NDI video on a large scale and while it's a fantastic technology, it can lead to frustrating network issues which may first appear as faults on specific and seemingly unrelated devices like a SKAARHOJ controller. In general, the problem is that NDI used on a poorly configured network that is not "NDI ready" will lead to flooding of NDI video data to devices that doesn't want it and can't handle it. For a SKAARHOJ controller this means that the essential control data connection is killed by all the irrelevant video data it receives. Even a single lost control package can lead to poor of connection stability or the use of a joystick. In the worst case the control won't even connect. These cases can be frustrating because they are tipping-point issues where a small change cascades into large consequences.

In general: For any network control system to work - and certainly for a SKAARHOJ controller - you need to consider that your network is configured so that neither the SKAARHOJ controller nor the devices it communicates with and no link in between are congested with network traffic that can result in predictably poor performance. No matter how much error correction we build into a controller, lost communication information will lead to poor performance. When NDI video data and other Multicast data is shared on a network it will congest the network unless proper guidance have been taken. Use proper managed network switches with something called IGMP snooping enabled so the lovely NDI data is only sent to the devices that wants to receive it. If not - and this is the default unfortunately - all devices including your SKAARHOJ controllers will receive it too and spend incredibly amount of resources to filter it out.

Below you will find our recommendations as this present time.

If you use our controllers on a network with NDI sources (Multicast) it is absolutely imperative to configure your network properly to ensure a stable connection.

Network Guidelines

Besides having taken proper network switch considerations such as Gigabit Ethernet on all network switch ports we recommend the following settings on your Managed Switch when possible:

- Enable IGMP Snooping (mDNS is automatically blocked by many switches when snooping is enabled – refer to documentation from your switch vendor)
- Enable Flow Control as Asymmetrical or simply as On
- Disable Quality of Service
- Disable Jumbo Frames
- CONFIGURE IGMP Querier and Query Interval for each switch in multi-switch networks when using multicast

Additional Resources

- **NewTek:** [NDI Network Guidelines](#)
- **PTZOptics:** [Setting up a Ubiquiti Network for use with PTZOptics Products](#)
- **NewTek Network Settings:** https://support.newtek.com/hc/en-us/articles/115001705074-NETWORK-SETTINGS?mobile_site=true

Multicast Data on Network

If you are unsure if Multicast data is present on your network we recommend using a network protocol analyzer such as Wireshark. Many tutorials can be found online to filter to Multicast data on the network.

See an example [here](#).

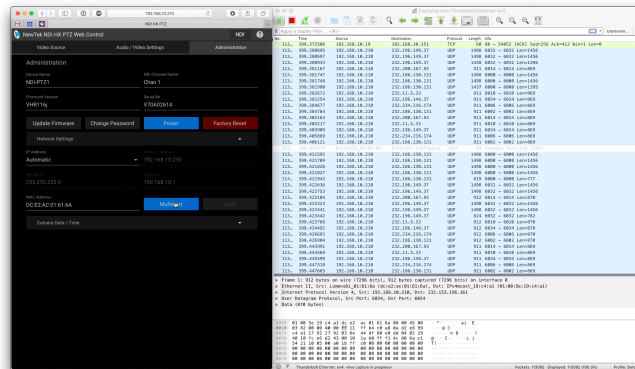

Recommend Managed Network Switches for NDI Network

We have tested 2 different managed network switches for a setup where multicast data is present. Below you will find a quick guide on how to configure these 2 devices to ensure stable connection on your network.

- Ubiquiti UniFi US-8-150W
- Netgear Click GS408EPP

At this current moment we advise against the **DGS-1100-08P** from D-link, **Netgear GS108T** and **Intellinet 561075** as we have experienced poor performance on this switcher. It can cause network devices to become unresponsive when a SKAARHOJ controller is connected.

Netgear Click GS408EPP

NETGEAR
 GS408EPP – ProSAFE Web Managed 8-port Gigabit Ethernet PoE+ Easy Mount Switch

System | VLAN | QoS | Help | Management | Maintenance | Monitoring | Multicast | PoE | LAG

Cancel | Apply

IGMP Snooping | IGMP Snooping Configuration

- IGMP Snooping Status: Disable | Enable
- VLAN ID Enabled for IGMP Snooping:
- Validate IGMPv3 IP header: Disable | Enable
- Block Unknown Multicast Address: Disable | Enable
- IGMP Snooping Static Router Port: any

Ubiquiti UniFi US-8-150W

UniFi 5.8.28

SETTINGS | Networks

EDIT NETWORK - LAN

Name: LAN

Purpose: Corporate | Guest | WAN | VLAN Only | Remote User VPN | Site-to-Site VPN | VPN Client

Interface: LAN | LAN2

Gateway/Subnet: 192.168.1.1/24

Gateway IP: 192.168.1.1
 Network Broadcast IP: 192.168.1.255
 Network IP Count: 254
 Network IP Range: 192.168.1.1 - 192.168.1.254
 Network Subnet Mask: 255.255.255.0

Domain Name: localdomain

IGMP Snooping: Enable IGMP snooping

DHCP Mode: DHCP Server | DHCP Relay | None

DHCP Range: 192.168.1.6 - 192.168.1.254

DHCP Name Server: Auto | Manual

DHCP Lease Time: 86400 seconds

DHCP Gateway IP: Auto | Manual

DHCP UniFi Controller: UniFi IP address

DHCP Guarding: Enable DHCP guarding

UPnP LAN: Enable UPnP LAN

ADVANCED DHCP OPTIONS | CONFIGURE IPV6 NETWORK

SAVE | CANCEL

Back Connections & Pinouts

This is a description of the connectors of the microprocessor we use in most of our products. Often referred to as the SKAARDUINO Due

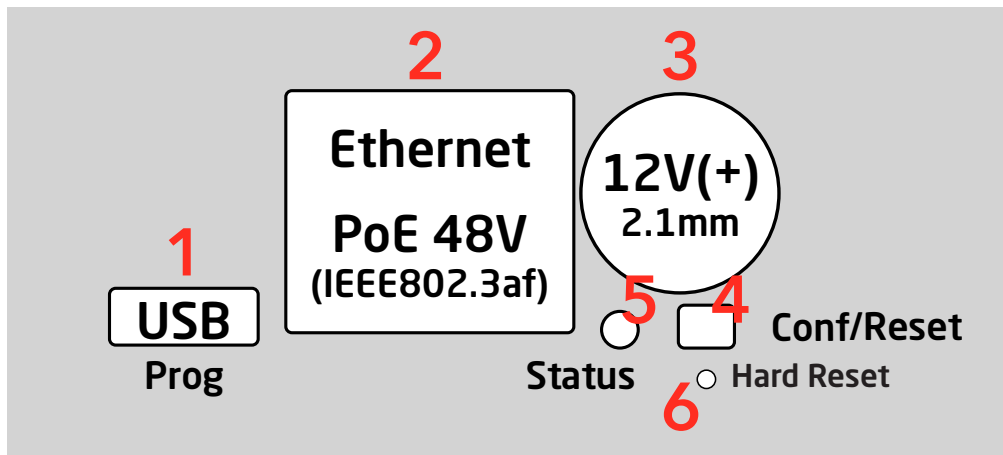

1. **Micro USB plug.** Used for service monitoring and programming new software into the unit (firmware upgrades).
2. **Ethernet Jack.** Connect this to your ethernet switch. This jack may also support PoE (Power over Ethernet) if your SKAARHOJ controller was delivered with that option. When connected to a network switch, the yellow LED (lower left) will be on. When data is sent to/from the controller, the green LED (lower right) will blink. If the device in the other end supports TX/RX auto detection you may be able to connect the SKAARHOJ controller directly to your device, otherwise use a crossed cable or a network switch (the supported setup).
3. **DC input.** Use a standard 2.1mm center pin plug (center = "+"). Allowed voltage range is 7-18V. We test controllers will work at 12V. The device uses max 1A at 12V. Units with Blackmagic 3G-SDI Arduino Shields needs 12V.
4. **Configuration/Reset button.** Use a pencil or tooth pick to press the button. When you press the button shortly, the controller will reset (same as pulling the power plug). If you press and hold the button, you can reset the controller into configuration mode (as as pressing "Local Configuration" in Firmware Application):
 1. Press and hold the button until the status LED becomes blue after a few seconds. Release the button and the controller is in *config* mode. You can access the controller web interface with a web browser on "[http://\[CONTROLLER IP\]](http://[CONTROLLER IP])" where CONTROLLER IP is the IP address used for the currently loaded preset. The controller will run a diagnostics mode after 2 minutes where displays and buttons will light up.
 2. Press and hold the button longer until the status LED becomes white (which is 2 seconds after becoming blue). Release the button and the controller is in config default mode. You can access the controller web interface with a web browser on "<http://192.168.10.99>". The controller will immediately run a diagnostics mode where displays and buttons will light up.
 3. Press and hold the button even longer until the status LED becomes red (which is 10 seconds after becoming blue and 8 seconds after becoming white). This will clear all presets in memory thereby resetting all configuration made in the controllers own web interface (this corresponds to the serial monitor command "clearpresets" and should only be necessary in case a firmware update requires it or if there is another tricky error state present).

In rare cases you cannot rely on the reset button but have to turn off the power to the controller instead ("cold start").

5. **Status LED:** When the controller is just powered up, you will see the status LED blink purple during the boot process. In this process, the hardware is initialized. Eventually the LED should end up blinking slowly (2 sec period) steady green (or blue or white if in config modes). If the LED blinks yellow quickly it indicates that connection to one or more devices is not established. This is perfectly normal for a few seconds between the boot up process (purple blinks) and the operational state (green blinks) when the controller connects to all devices. The status LED should never be permanently on or off, this indicates a potential freeze in the system. In fact, in normal healthy operation the LED should blink with a steady 2 sec period, otherwise it could indicate trouble with connections or hardware. The LED will also light up red for a split second whenever an analog hardware component (such as a T-bar) is operated (this feature is helpful to determine if calibration is needed).

6. **Programming Mode Reset:** Will make a hard reset of the controller leaving it with *no* firmware. Is used if the controller does not appear in the Port list in the Firmware Application. Only to be used prior to have consulted SKAARHOJ Support. Please see section: [Controller does not show up under Port in Firmware Application](#).

Status LED Overview

Purple blinks, uneven durations	The controller is booting up (and for each blink a given step has been completed).
Yellow blinks, quickly	<p>The controller hasn't established necessary connection to one or more devices. At the end of the boot process this is natural for a few seconds as the controller connects to devices for the first time.</p> <p>If you unplug the network cable or turn off an external device the controller is connected to, you will also see this state. Just turn on the external device again or re-insert the cable and the error state should restore itself to normal operation (green, steady blinking) after some time.</p> <p>If this happens during normal operation and without obvious explanations (like removal of a network cable or shutting down an external device), it's an error state you need to pay attention to and bug-fix further.</p> <p>If the controller boots up and never stops blinking yellow, you may want to check if you have configured devices for the controller which are not currently present in the network set up. Go to config mode, enter the web interface and check which devices are enabled and their IP addresses.</p>
Green blinks, steady, period of 2 seconds	Normal mode, everything is connected and working properly. Just bliss
Blue or white blinks, steady, period of 2 seconds	Config mode (white: "config default") where you can access the controller web interface.
Red blinks (interrupting green or yellow blinks)	This happens if you move an analog hardware interface component like a T-bar or knob and is totally normal in that case. However if such blinks happen without you touching any analog components it indicates the need for calibration.
Quick red blinks and no response from controller	A problem with the preset memory checksum indicates that the preset memory may be corrupt. However, in most cases a "cold start" by removing the power supply, waiting 10 seconds and connecting the power supply will solve the problem. If after 2-3 attempts with this solution it still remains a problem, you must clear the preset memory. This is done by holding the config button pressed, then apply power to the controller and wait for around 15 seconds until the status LED becoems solid red (before that state, the LED should be first purple, then blue, then white for 8 seconds and finally solid red). When the LED is red, release the button and the status LED should start blinking again and the controller should boot up. Notice that your controller will be reset to factory settings in this case and you may need to reload or recreate your configuration.

Pinouts

DB-25 Connector Configuration for GPI

This is the pinout for the DB25 Connector we use as a GPI module:

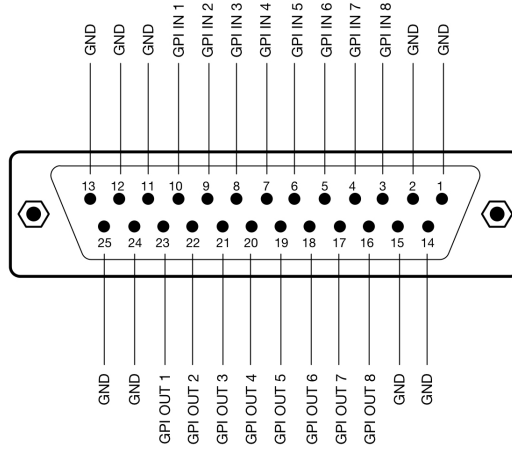

This is the pinout for the DB25 Connector we use on the SDI-GPI Link:

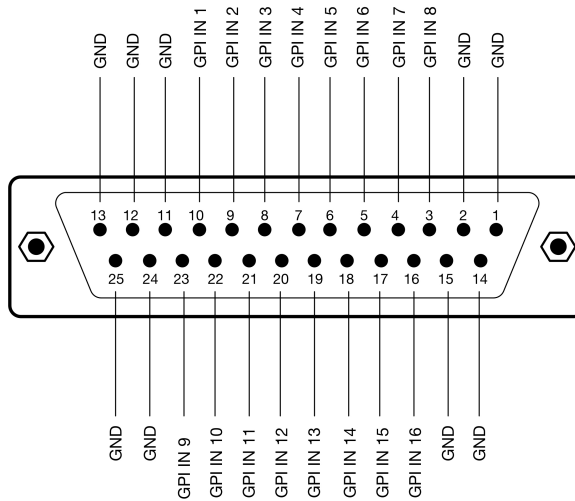

DB-9 Connector Configuration for RCP units (EXT I/O)

This is the pinout for the DB9 we use on our RCP units. Often a default RCP configuration will be configured so:

- When the joystick top button or the "Prev" button is pressed, a relay is shorting pin 1 and 2
- If pin 8 is shorted to GND (pin 5 or 9) the display backlight will change from white to red/the Tally bar will light red (if configured)

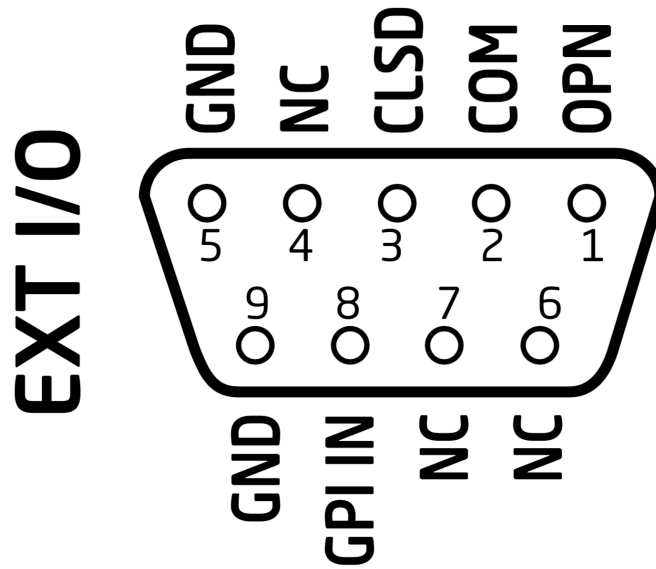

Pinout for Tally Box

The pinout of the RJ-45 connector is as follows:

1. GND
2. 12V
3. 5V control signal for red tally 1
4. 5V control signal for green tally 1

The next four are for daisy-chaining tally lamps:

5. 5V control signal for red tally 2
6. 5V control signal for green tally 2
7. 5V control signal for red tally 3
8. 5V control signal for green tally 3

Our tally lamps need 12V power in order to light up the LEDs. The control signals are 5V so whenever you apply 5V on one of the pins the corresponding LEDs will illuminate.

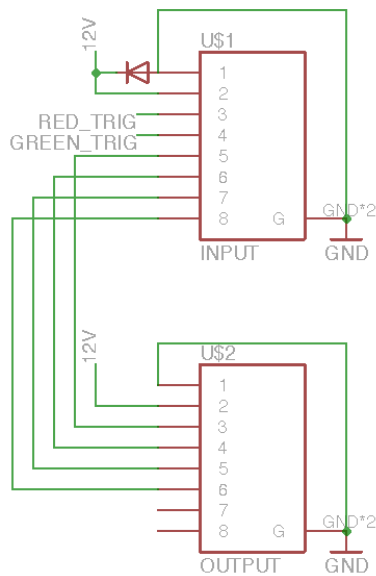

- 1=O/ (GND)
- 2=O (12V)
- 3=G/ (Red, Lamp 1)
- 4=BL (Green, Lamp 1)
- 5=BL/ (Red, Lamp 2)
- 6=G (Green, Lamp 2)
- 7=BR/ (Red, Lamp 3)
- 8=BR (Green, Lamp 3)

Embedding CCU data on the the 3G-SDI return feed

For controllers with the SDI option, you find a 3G-SDI in and out BNC plug. Route the return feed to the camera through this connection to insert CCU data on the signal.

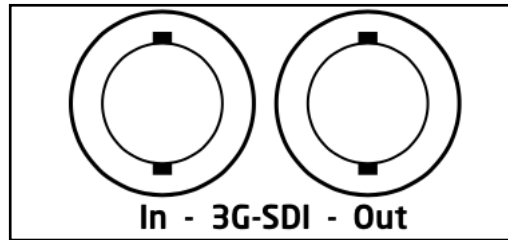

If you use the Blackmagic 3G-SDI Arduino Shield for camera control the following outputs are supported: 720p50, 720p59.94, 720p60, 1080i50, 1080i59.94, 1080i60, 1080p23.98, 1080p24, 1080p25, 1080p29.97, 1080p30, 1080p50, 1080p59.94 and 1080p60, but the camera doesn't have to be running the same video format as the program input, so you can use cameras in Ultra HD while the camera protocol is sent over HD signal to the camera.

BMD Camera Support

SKAARHOJ units with the SDI option controls any Blackmagic camera that supports CCU over the return SDI feed. The CCU data is inserted on the SDI return feed.

Locking Connector for 12v Power Supply

To convert the plug on your 12v Power Supply to one with a locking connector we recommend the following model:

Mouser Electronics P/N: 171-7391

<https://www.mouser.dk/ProductDetail/Kobiconn/171-7391?qs=%2Fha2pyFaduhDw2idj%2Fw19LiuYoXcmlZz1a2fwh4gQAw%3D>



Troubleshooting

Cases

Here you will find some cases and suggestions on how to resolve them

Nothing happens when I press "Online Configuration" or "Local Configuration"

Typically this is because the Firmware Application is not able to retrieve the unique hardware number of the controller (CID number).

- Try to power cycle (take power, wait 10 seconds, reconnect power) and try again
- Try to press "Clear Presets" in Serial Monitor and try again after reboot
- Reload firmware onto the controller via "Update Firmware" in the Firmware Application. Accept installing of intermediate software version if prompted with this.

Error: Unsupported Device

Typically this is because the Firmware on the controller is corrupted. Or the Firmware Application is unable to retrieve the unique hardware number of the controller (CID number).

- Restore firmware by pressing "Update Firmware". Accept installing of intermediate software version.

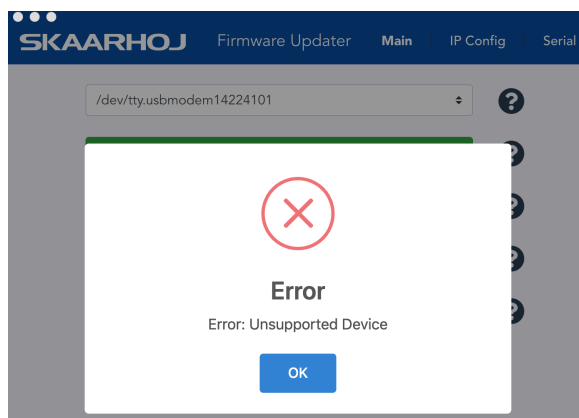

Controller does not perform regular color cycle in buttons/content in displays during boot up process but still appear in Port list in Firmware Application

Typically this is because the firmware on the unit have somehow been corrupted

- Try to press "Clear Presets" in Serial Monitor
- Reload firmware onto the controller via "Update Firmware" in the Firmware Application

Controller will not connect to PTZ Cameras

Remember in most cases only one PTZ Device Core should be enabled on the controller. This will connect to multiple cameras if they have consecutive IP addresses

- See details in "PTZ Manual" at <https://www.skaarhoj.com/support/manuals/>

I have a suspicion that a display/button is not working properly

In order to rule out that something “not working” is not related to configuration error you can put the controller in a test mode where it cycles colors in buttons and content in displays.

- Put controller in configd mode by writing configd in the serial monitor (see also [commands in serial monitor](#))

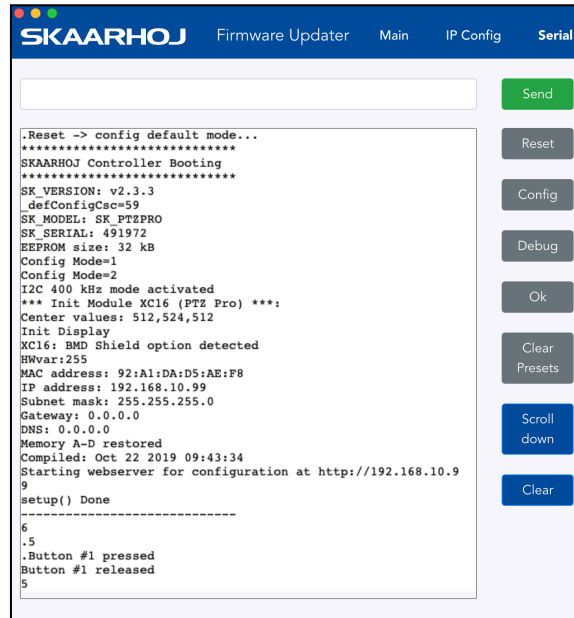

Serial Monitor reports “Presets checksum mismatch” upon boot up

Typically this is because the firmware on the unit have somehow been corrupted

- Press “Clear Presets” in Serial Monitor

```
*****
SKAARHOJ Controller Booting
*****
SK_VERSION: v2.3.2
_defConfigCsc=20
SK_MODEL: SK_E21GPIO
SK_SERIAL: None
EEPROM size: 32 kb
Presets checksum mismatch. Attempt #0 Data: FF:FF:FF:FF
:FF
Presets checksum mismatch. Attempt #1 Data: FF:FF:FF:FF
:FF
Could not read presets in 2 tries. Serial recovery mode
.
```

All I see in the Serial Monitor is numbers

This is perfectly normally. The dot and numbers indicates the number of times a second the controller manages to check all device connections and hardware components. See more in the [Serial Monitor](#) section. If you press “Reset” in the serial monitor the controller will boot and you will see the boot up message with details about the controller.

Firmware File Download is 0kb

Sometimes we experience an error on our download server resulting in the downloaded firmware file being empty. The file has the size of 0kb, and can not be used to load into the controller.

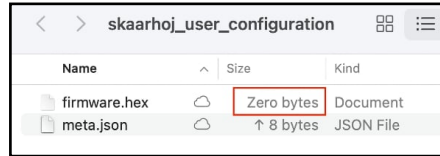

Name	Size	Kind
firmware.hex	Zero bytes	Document
meta.json	↑ 8 bytes	JSON File

Please follow these steps to download from an alternative server. (See images below)

1. open SKAARHOJ Updater app
2. open 'Options' menu > click to enable 'Expert mode'
3. click the 'Online Configuration (Staging)' button
(Being in expert mode, this takes you to the alternative Staging server)
4. on the webpage, click the red 'Advanced' button, top right of window
5. click 'Firmware Overview' in the main menu
6. click 'Download' to download any of the available firmware files

To load the file into the controller, please return to SKAARHOJ Updater app > open 'Options' menu > click 'Load Firmware from file' > select the downloaded 'firmware.hex' file.

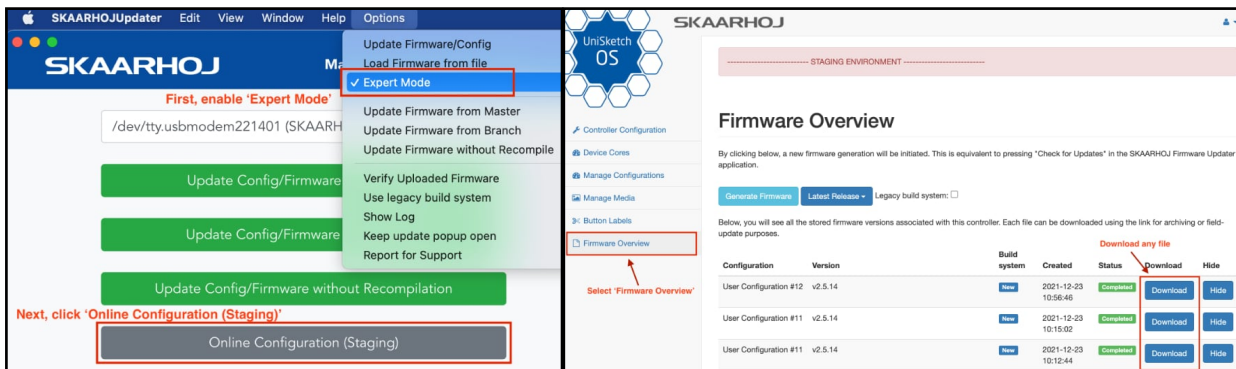

Recovery Process for Overloaded Controllers

There is a limit to how many device cores you add to a configuration. Some device cores takes up more CPU-power than others, and if too many are added the controller can become unresponsive or crash.

See our suggestion to the device core count on the Device Cores webpage:

<https://www.skaarhoj.com/support/device-cores> - it is listed as 'Core limit'.

It's also important to note that many PTZ device cores can handle multiple cameras - often up to 7 or 8. This means only one device core is needed to control the cameras, if they are of the same model/family. The camera limit is also found on the Device Cores webpage - it is listed as 'Client limit'.

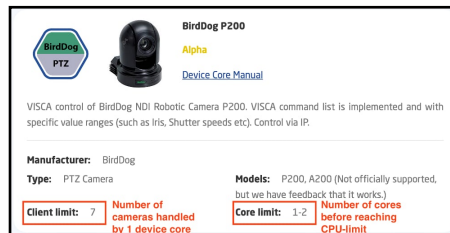

If too many device cores have been added, and the controller has become unresponsive, it is necessary to remove some device cores from the configuration.

If the Online Configuration webpage is still open, select 'Device Cores' in the menu, and click the red X to delete one or more device cores.

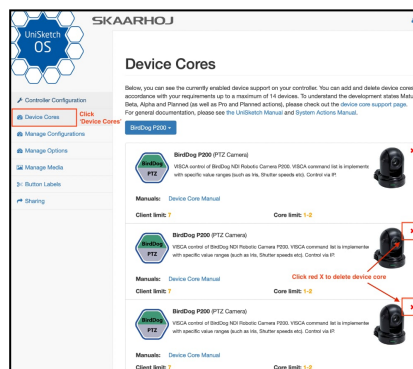

After removing device cores, please remember to click 'Save Settings' - then click 'Controller Configuration' in the menu, and again click 'Save Settings'. Go to the Firmware Overview page and generate a new firmware for the controller. Download and unzip the file. Return the Firmware Updater and select Options/ Load Firmware from File. Select the unzipped .hex file.

The controller should now have returned to an operational state. It can also be a good idea to press Clear Presets in the serial monitor portion of the firmware updater to make sure all the old firmware has been wiped away.

If your controller is totally unresponsive, and you can't access Online Configuration, then you need to contact Skaarhoj support.

Enable Local Configuration by default

As mentioned in the “[Local Configuration](#)” section the local web server is not enable by default. This can be achieved by putting the action “**System: Web Config**” in the Controller Hardware Component “Controller” (typically found as a component top far right/left). Save and generate a new firmware.

An alternative by having it on by default is to assign the action “**System: Web Config**” to a button for one to manually turn the web server on/off.

The screenshot shows the SKAARHOJ web interface for configuring a Live Fly controller. The browser address bar shows the URL `cores.skaarhoj.com/?page=controllerSetup`. The page title is "Configure your Live Fly".

On the left, there is a navigation menu with the following items:

- Controller Configuration
- Device Cores
- Manage Configurations
- Manage Options
- Manage Media
- Button Labels
- Sharing

The main content area features a "BMD ATEM" logo and an "Add devices" button. A central diagram shows a virtual controller layout with various buttons and controls, including a "Size:" slider above it. Below the diagram, there is a checkbox for "Open All Configuration".

The following additional states are enabled in the configuration below. States can be hidden to ease the configuration.

Enabled states: AUX, Media, Macro, Audio, DVE

Devicecore actions can be hidden from the select lists as well to make configuration faster. (Note: This does not work in Safari)

Enabled actions: BMD ATEM Actions, System Actions

At the bottom, there is a "Controller" component configuration section. It includes a "Home" dropdown menu set to "System: Web Config" and buttons for "AUX", "Media", "Macro", "Audio", and "DVE". Each button has "INS" and "CP" icons. A "Save Settings" button is located in the bottom right corner.

Controller does not show up under Port in Firmware Application

If your controller doesn't show up under ports, try these things first:

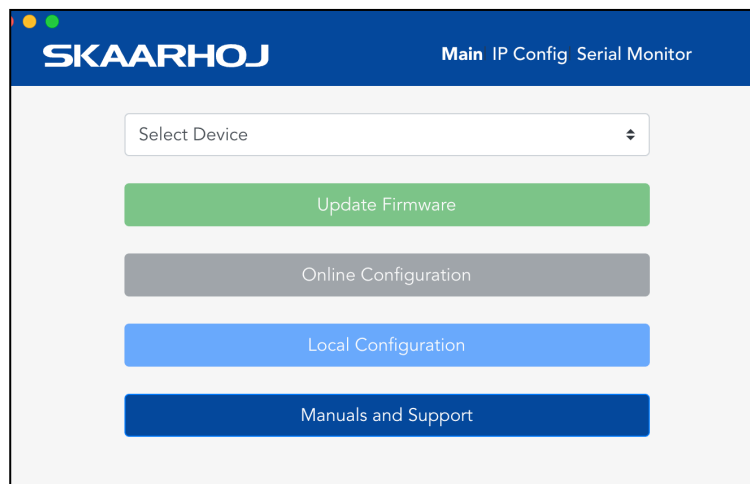

- Make sure you have attached your controller with a micro USB cable to your computer. Check the micro USB is fully inserted into the USB plug on the controller
- Is the controller turned on?
- Reboot your computer
- Change the USB cable for another one
- Avoid using USB adapters to eliminate point of failures
- Try to use a different USB port on your computer
- Boot the controller in config mode: Disconnect the controller's power, then hold the config button under the power plug down with a pen tip, power on the controller and hold the button until it lights blue, then release.
- Force quit and reopen the Firmware Updater.

If none of the above brings up the USB port, you may try this procedure **but only after clearing it with the SKAARHOJ support team!**

- Locate the small hole just below the config button
- Power off the controller and press this tiny button for a second, add power and release the tiny button after 5 seconds. You may repeat this. (Pressing this button while the controller is on should reset it completely).
- Turn off the controller, then turn it on again. Now you should see the USB port in the firmware application and be able to perform a "Update Firmware" (which at first will ask to install an intermediate firmware which you agree to).

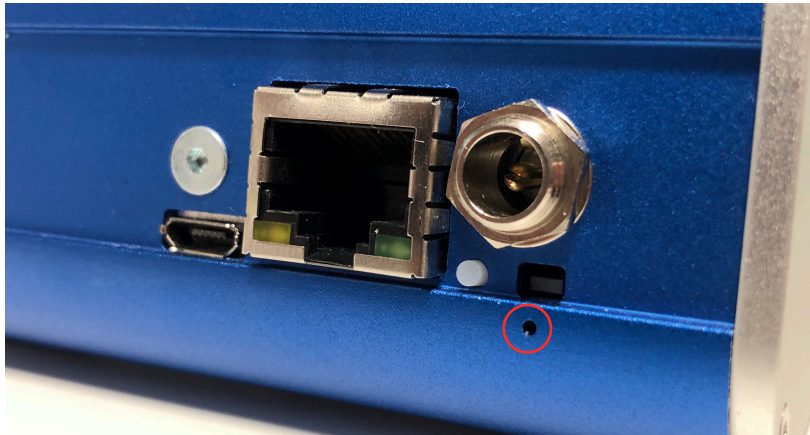

Old method if no hole below config button are present:

- Open the controller carefully and locate the SKAARDUINO main board (the one with the ethernet plug)
- Locate the flat cable connector in the corner of this board. Next to this connector you will see a tiny button.
- Power on the controller and press this tiny button for a second and release. You may repeat this. (Pressing this button while the controller is on should reset it completely).
- Turn off the controller, then turn it on again. Now you should see the USB port in the firmware application and be able to perform a "Update Firmware" (which at first will ask to install an intermediate firmware which you agree to).

Contact Support

You are always welcome to contact us for support questions - write an email to support@skaarhoj.com and we will do our best to accommodate your request.

In order for us to provide the best support please state:

- Which SKAARHOJ unit it is about
- The serial number of your device (small silver label with 6 digits)
- The nature of the problem
- Which hardware device(s) you are controlling and their firmware version
- If you have successfully installed the Firmware Updater Application and made contact with your device though the Serial Monitor (you need the USB programming cable)
- Your operating system

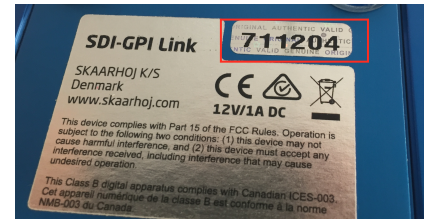

UniSketch OS Explained

Configuration Page

When you press "Online Configuration" in the Firmware Application you will access the unique Configuration Page for your controller with a list of default configurations. We recommend using the Chrome browser because it's faster, but we have successfully tested it with other modern browsers such as Firefox, Safari and Internet Explorer in the latests version.

Notice that the web interface heavily depends on modern JavaScript and may malfunction with older browsers!

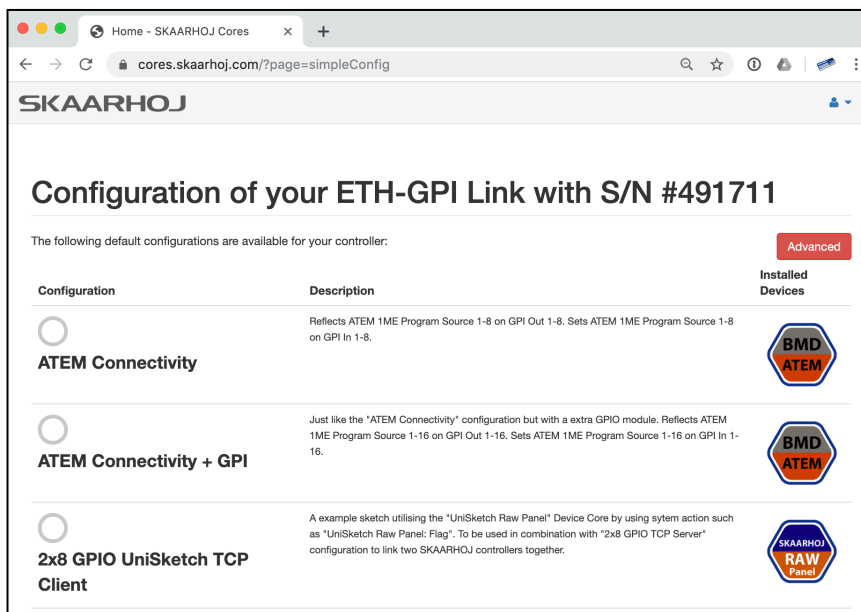

Example of Configuration Page interface for ETH-GPI Link

Device Settings

You set up the IP address, Subnet mask, Gateway and DNS of your SKAARHOJ controller on the Configuration Page. Likewise any external IP device your controller is configured to work with (Device Cores) is listed here. Any device you want to be active must be enabled here and have a valid IP address set up.

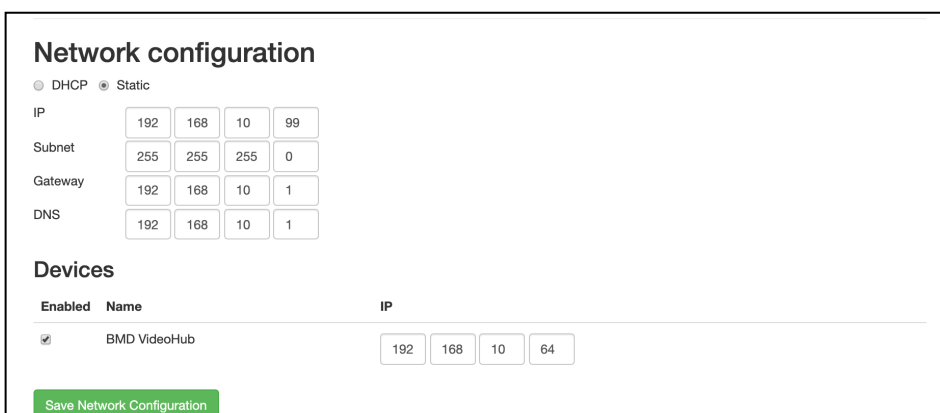

You select a default configuration or you can create your very own. Press the "Advanced" tab in order to access additional configuration possibilities.

Hardware Interface Components (HWC)

Your SKAARHOJ controller consists of a number of hardware interface components such as buttons, knobs, dials, levers, displays, LEDs, joysticks, plugs, etc. They generally fall into broad categories such as inputs (eg. buttons and knobs, GPI) or outputs (eg. displays, LEDs, relay). Sometimes they can be both (most buttons have an illumination color, some even have a display on them). Input elements can be sub categorized as:

- “binary” such as a button or GPI trigger which is either pushed/triggered or not. Sometimes holding down a binary input has a special function.
- pulse-generators such as encoders which are knobs that can rotate indefinitely in both directions and sends a corresponding number of pulses. Encoders typically has a fine/coarse adjustment mode which is toggled by pressing it. Pressing and holding an encoder down for 1 second will typically send a binary “button down” signal to the interface component. Often this can function as a “reset” feature.
- analog signals such as T-bars or joysticks which provides a free value within some range.

Outputs range from a simple binary output like a relay to red/green LEDs, an array of LEDs (like a VU meter) or a graphical or text based display.

Hardware Interface Components are configured with actions which is what give them their function. This is described in the next sections.

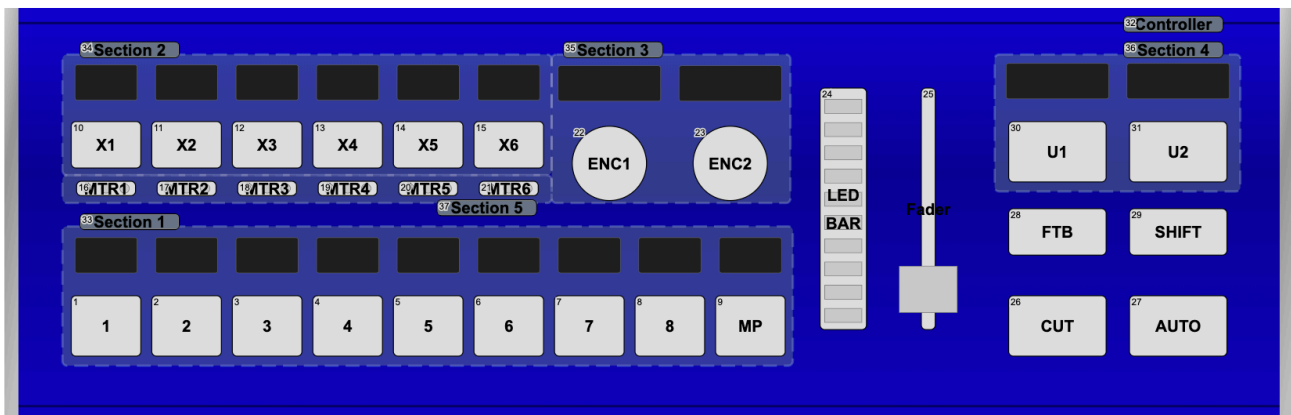

An example of the schematic drawing of a controller as found on the advanced section of the Configuration Page

#7 KEY 1|KEY 2

KEY 1
KEY 2

ATEM: Upstream Keyer M/E 1 USK 1 Toggle CP -

or (shift) ATEM: Upstream Keyer M/E 1 USK 2 Toggle +

This is how the button “KEY1 / KEY2” is configured in the web interface. As it appears, this button will toggle upstream keyer 1 or 2 on an ATEM switcher depending on whether the controller is in shift-state or not.

Graphical Displays

Displays are found in many configurations on SKAARHOJ controllers. Typically a display is paired with a button or an encoder. Sometimes a display is stand alone but can be configured to reflect a certain button on the controller (through the "Tie to HWC#" system action). An important convention with displays is whether it works as a label or displays a current status. Take the picture below as an example. Here there are two SmartSwitch buttons apparently showing the same thing:

- **A label:** The button to the left is configured to set the frame rate of Mix transitions to a fixed "24f". This can be seen from the fact that the button has a non-solid header bar. This is a *label* that simply tells us what will happen if you push the button: You will set a 24 frame mix transition rate.
- **A status:** The button to the right is configured to also set the frame rate of transitions but is configured to act in "Cycle" mode so when you press the button you will cycle through transition types and values by some scheme. The important thing is that the button shows the current value for Mix transitions - 24 frames. And if we change the value to 30 frames, the button will show 30 frames. This is a *status* that informs you about the current value of this ATEM feature and this can be seen from the fact that the button has a *solid* header bar.

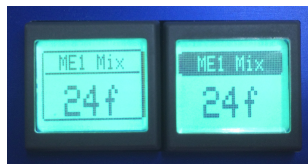

This convention works throughout all displays on your SKAARHOJ controller. Generally, a display will show the value status unless it has been tied to a button-type interface component in which case a label is typically shown - unless the particular button operates in some sort of cyclic mode where a status makes more sense to display.

By default the graphical displays are set to a Sleep Timer of 2 hours to prevent burn in. We strongly suggest keeping the sleep timer to avoid burn in on the displays. Please note that burn in is not covered by the 1 years hardware warranty.

Actions

You configure your controller by assigning actions to interface components. An action is most typically a command sent to an external device, such as a video switcher, router, recording deck, monitor etc. External hardware support is made available on your controller as what we call *device cores*. A device core is the driver - or akin to an "app" - installed on the your controller that enables communication support with a given piece of broadcast gear.

Some actions may also relate to internal registers or "system functions". For instance you can have a button set or clear a "shift" value which the rest of the interface components will adapt itself to.

Since interface components can be inputs and/or outputs and of various types, the way they affect any given device via an action is a fixed interpretation coded into the system.

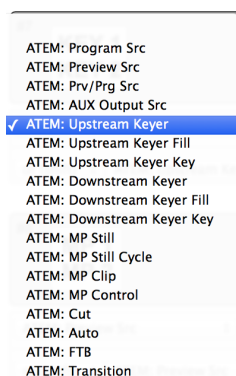

An excerpt of the list of ATEM switcher related actions.

Multiple Actions

You can assign multiple actions - even on different devices - to any interface component. This is done by simply pressing the "+" button and setting up the new action:



In this case, the media player 1 (MP1) is brought on Preview on an ATEM switcher and right after the still number 5 is selected for the media player 1.

The return values, including those driving a display, will always come from the first action in the list (of the current shift level).

Notice that multiple actions are separated by an "operator" which is either "and" or "or (shift)":

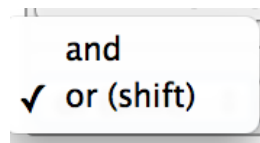

This is explained in the following.

Shift

You can assign a button to set a shift state on your controller. Even though a shift state sounds like an either/or option, we have implemented the possibility to have multiple *shift-levels*. However, in the simple case, a shift button would be configured as shown below:



This will set the shift-level "1" in the system as long as the button is held down, otherwise it will be "0" (normal)

This means another button on the same controller could be configured like this now:



And because the divider between them is "or (shift)", the second action is only active when the shift button is held down.

If no specific action is defined for a shift level, the interface component will use the default list of actions.

If you insert additional "or (shift)" dividers, it will define how shift levels 2 and beyond will act. Within each shift level you can have multiple actions (see previous section).

States

Similar to shift levels you can put your controller in various states. States are mainly different from shift levels by the way the interface lets you set them up. With three states you see three columns of actions for each interface component:

The image shows three examples of controller interface states, each with a header bar and three columns of controls:

- #36 Enc7:** Features three columns: BLACK/WHITE (ATEM: Gain, G, Mem A), BLACK/GAMMA (ATEM: Gamma, G, Mem A), and CAMERA/CBSH (ATEM: Saturation, Mem A, 0).
- #37 Enc8:** Features three columns: BLACK/WHITE (ATEM: Gain, B, Mem A), BLACK/GAMMA (ATEM: Gamma, B, Mem A), and CAMERA/CBSH (ATEM: Audio Volume, 11).
- #38 ID Display:** Features three columns: BLACK/WHITE (System: Flag, Flag: 0, Feedback Flag: 1), BLACK/GAMMA (+), and CAMERA/CBSH (+).

Like with shift levels you can assign other interface components to change the state of the controller. If actions are not defined in any given state, they will fall back to the action list in the first column (Normal state).

States and shift levels can be combined of course; you can have unique shift levels inside each state.

States can also be named. In the above example, they are named "BLACK/WHITE", "BLACK/GAMMA", "CAMERA/CBSH". This is done in the controller web interface as well:

States

The screenshot shows a dropdown menu for "States: 3" with the following options:

- BLACK/WHITE
- BLACK/GAMMA
- CAMERA/CBSH

This is where you select how many states the controller should support.

Virtual Triggers

Virtual Triggers are available on all UniSketch OS controllers and allow the user to add increased functionality to a controller where a hardware component might not be needed.

Virtual Triggers (Alpha)

Source states	Operator	Actions
<input type="button" value="Add trigger"/>		

There are three parts to a Virtual Trigger:

Source state- The action(s) you want to trigger another event

Operator- Sets the conditions for the trigger. Setting to Active enables the trigger. Invert will execute the trigger when the conditions of the Source State are not TRUE. AND (all) will activate this trigger if ALL specified conditions in source state are TRUE. OR (any) will activate trigger if AT LEAST ONE source condition is TRUE. Lastly, XOR will activate trigger if ONE OR THE OTHER (but not both) source state conditions are TRUE. This could be interpreted for multiple sources as "if there is at least one different value, f.ex. 5 sources are TRUE and one is FALSE". If all are TRUE or all are FALSE, this will not activate.

Actions- The action(s) you would like triggered by another event

Example: setting camera tally from a BMD Atem using Virtual Triggers.

Source states	Operator	Actions
BMD ATEM: Preview Src M/E 1 1 <input type="button" value="Add source"/>	<input checked="" type="checkbox"/> Active AND(all) <input type="checkbox"/> Invert Delay (ms) 0 Duration (ms) 0	Lumens VC-A61P: System Cam 1 Tally Hold Down <input type="button" value="Add action"/>

Copy / Paste

Often you will find yourself needing to set up almost the same function on multiple interface components (such as a row of buttons, all sending inputs to an AUX channel). To make this easy, make sure to use the Insert / Copy / Delete functions:

As soon as you make any change to a given interface components action list, this will be copied to memory so you just need to go to the next interface component and press "INS" for insert.

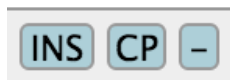

Auto Fill

When you need to set up the same function on multiple interfaces with only the difference of the function's parameters, such as adding camera selects or presets, you can press SHIFT + CP (in the configuration). This will open up the Auto Fill to allow you to enter the number of increments to increase the copied function.

Example: Pressing SHIFT + CP for the Camera Select function will open the Auto Fill with 3 boxes. The first box corresponds to the camera number, the second box to the Mem group, and the last box to the function modifier. Leaving a box empty will not increase the increments of that parameter.

Exp	Auto Fill (ALPHA)
Lumens VC-A61P: Camera Select Cam 1 Mem AA Set/Add <input type="button" value="CP"/>	Insert desired increment value in corresponding input (each input belongs to one parameter) to automatically increment specified parameter with each consecutive insert. • Camera Select - <input type="text"/> <input type="text"/> <input type="text"/> <input type="button" value="Apply increments"/>

Presets vs Online Configurations

Two methods exist for creating Configurations. We recommend making the configuration via "Online Configuration" so your configuration is always stored on the server, and can be recalled later.

An alternative is to create a local preset. At the bottom of the web interface on the local configuration you can load, save and reset your presets. Your controller can theoretically hold any number of presets only subject to the memory usage related to storing them. Pressing the save button in the web interface will save the configuration to the currently selected preset, but you can also select a new or different preset to save to using the selector box.

Load the "(Default)" preset to get back to the factory configuration.

If your presets seem to be messed up for some reason (could be memory overflow which there is currently no protection against) you may need to clear the entire memory by using the serial monitor command "clearpresets".

Presets are a very powerful way to make use of your controller in multiple places since it can change the entire behavior of the controller including which devices to connect to and which IPs they are on.

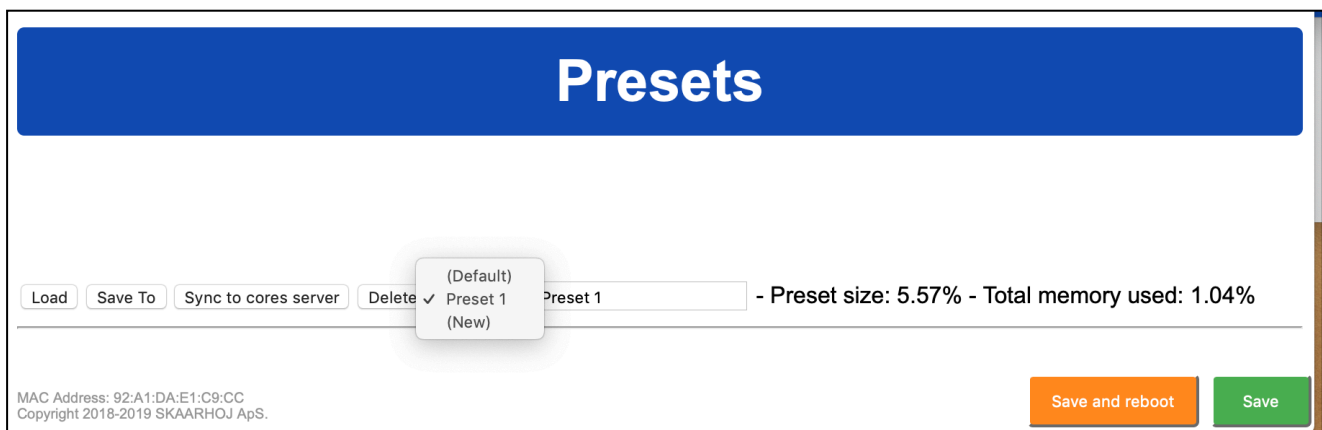

There is a nifty way to load presets on most controllers if you have created more than 1 preset: When you boot your controller, you may see that a number of buttons (corresponding to the number of available presets) light up for a few seconds and one of them being highlighted. The highlighted button indicates the currently loaded preset and the other buttons represent other presets. If at this moment you press and hold any of the other buttons down until that button lights up, you will then change the preset of the device (corresponding to selecting it in the web interface and press the "Load" button).

Presets are a great way to manage multiple configurations in off-line situations. However, using cores.skaarhoj.com and the firmware application to manage multiple configurations for your controller is more powerful in the sense that you can include changes to installed device cores, string and image media and also have the latest software updates installed.

Please notice you can use the "Sync to cores server" to load a "Local Configuration" onto the online Configuration Page of your controller.

Notice: Presets will be automatically cleared if a firmware update indicates that the online configuration has changed. In other words: Always be cautious with firmware upgrades and make sure you "print out" important local configuration so you can recreate it if necessary.

Various Examples:

ETH-GPI Link + Controller Server/Client Combinations

With the Device Core "TCP Server" and the Device Core "UniSketch Raw Panel" (Client) you can network SKAARHOJ controllers in unparalleled ways - not just two controllers but whole groups of them if you please. A separate tutorial called "**Server/Client Combinations**" can be found with details and examples on how to build such setups. Find it under Tutorials at <https://www.skaarhoj.com/support/manuals/>

Triggering Actions from Binary Inputs

Some of our products such as the ETH-GPI Link have an option to interpret binary inputs. This is used in cases where one would like to have routing control or the like from a device such as the Panasonic AW-RP50 or the AW-RP120 PTZ controller.

<Output states of GPI OUT1 to GPI OUT4 when the camera number registered to CAM OUT is selected>

	Output of GPI OUT1 to GPI OUT4			
	GPI OUT1	GPI OUT2	GPI OUT3	GPI OUT4
CAM OUT1	On	Off	Off	Off
CAM OUT2	Off	On	Off	Off
CAM OUT3	On	On	Off	Off
CAM OUT4	Off	Off	On	Off
CAM OUT5	On	Off	On	Off
CAM OUT6	Off	On	On	Off
CAM OUT7	On	On	On	Off
CAM OUT8	Off	Off	Off	On
CAM OUT9	On	Off	Off	On
CAM OUT10	Off	On	Off	On

Example of Tally output from the manual of the Panasonic AW-RP120

Fixed Routing

The two below examples shows how a configuration should be made to trigger ATEM AUX routing our Blackmagic Design VideoHub routing. In these cases the routing is fixed so CAM1 from the AW-RPx will *always* correspond to CAM1 in the ATEM and Input1 in the VideoHub.

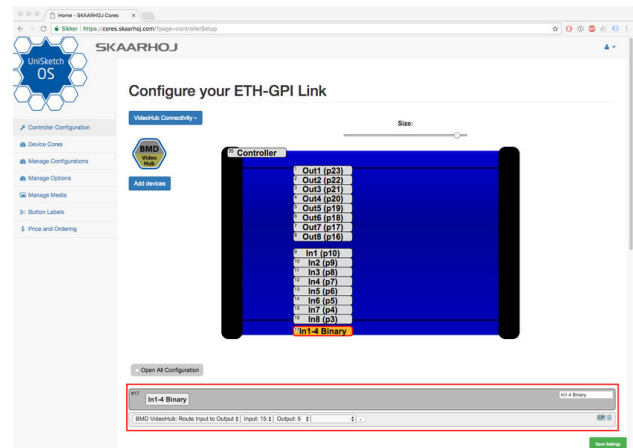
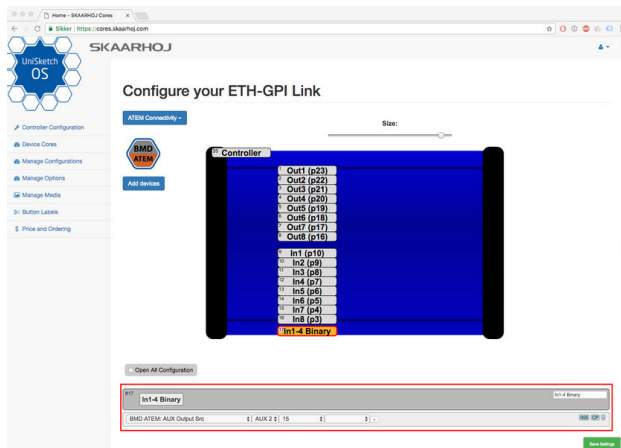

Flexible Routing

In some cases it is not desired to have the fixed coloration between CAM1 on the AW-RPx and CAM1/Input1 on the ATEM/VideoHub. The guide below explains how you achieve your desired routing.

Use the default configuration "Binary AUX Routing"

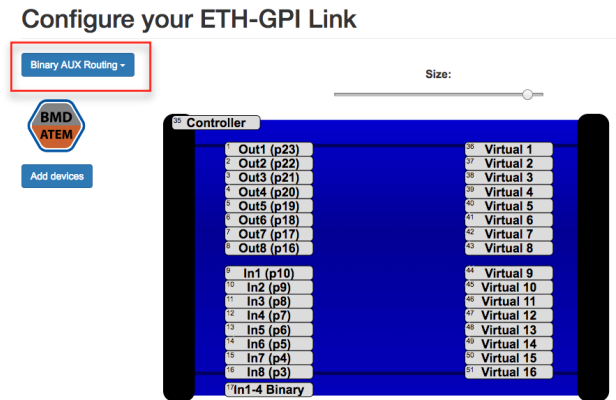

The "In1-4 Binary" is set to "System: Memory A". This will generate a memory parameter, A, in UniSketch which we will use to do our routing. If CAM1 is selected on the AW-RPx the memory parameter will be A=1, if CAM2 is selected it is A=2 and so forth.

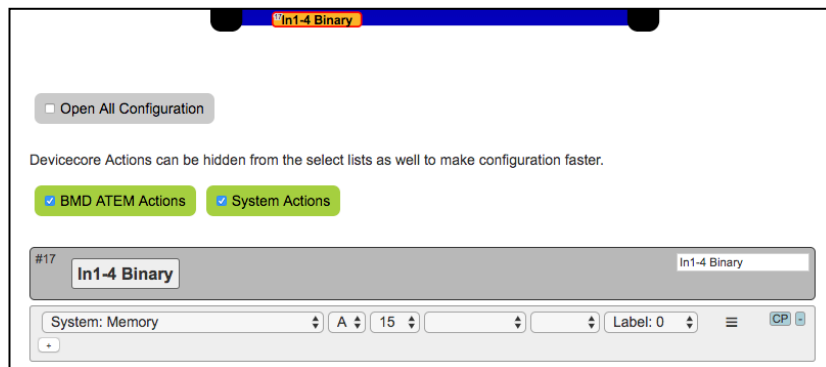

Now we will utilise the Virtual Hardware Components called "Virtual 1" and use the command "System: Synthesized Trigger" to trigger an action. In this case we set it to source 1 for AUX 1 on the ATEM. But you could as well do it for a different source or a entirely different action such as routing on a Blackmagic VideoHub or a AJA Kumo Router.

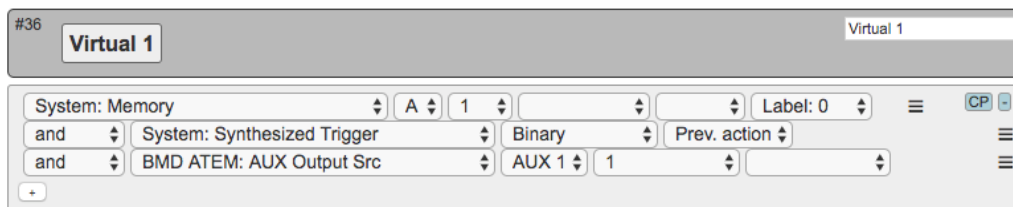

The same procedure is followed for "Virtual 2. Again you can leave the routing as it is, or you can alter the AUX routing or select a entirely different action.

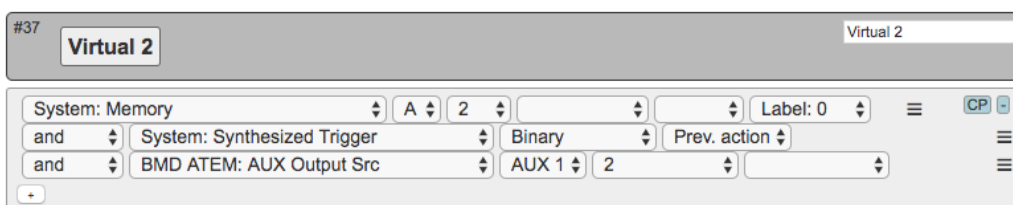

And then you continue to configure the routing you would like.

You do not need to configure different Virtual Hardware Components - more commands can be assigned to just one like illustrated below. However for the sake of overview and to avoid making mistakes using individual Virtual Hardware Components can be recommended.

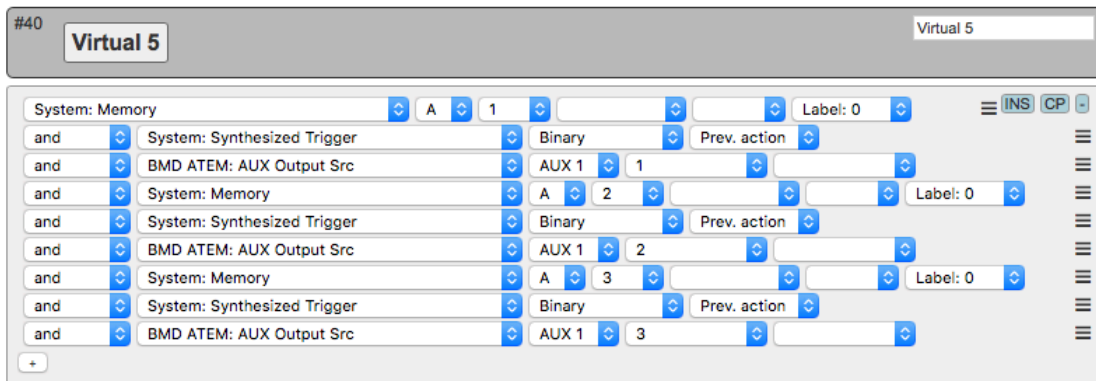

Example

Here is a readout from the Serial Monitor for a ETH-GPI Link connecting to a VideoHub and GPI1 being triggered. Notice that memory A is set to 1 which entails a binary trigger and finally the VideoHub action.

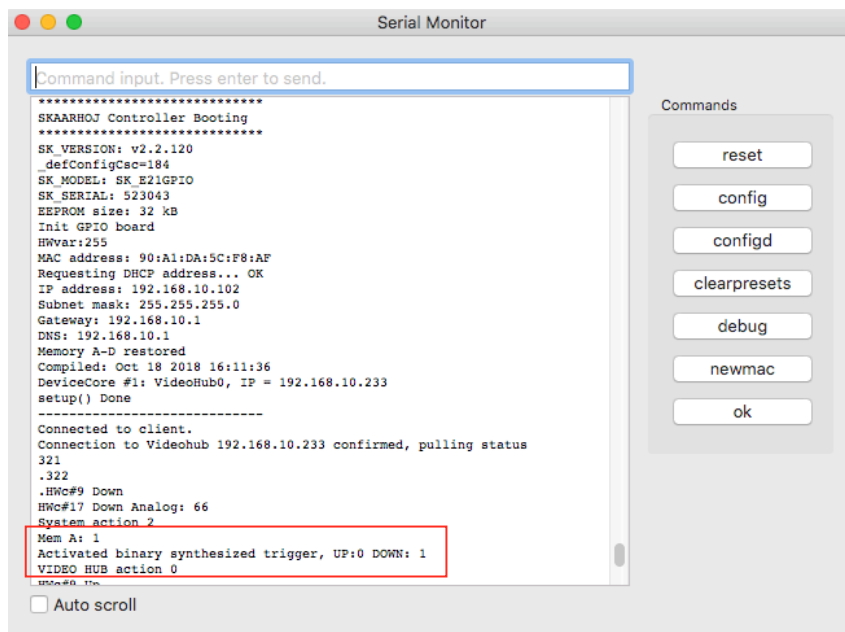

Cable and AW-RPx setup

Make sure the cable between the AW-RPx and the ETH-GPI Link is correct. Pin 10, 11, 23, 24 + GND on the AW-RP120 should be connected to pin 10, 9, 8, 7 + GND on the ETH-GPI Link.

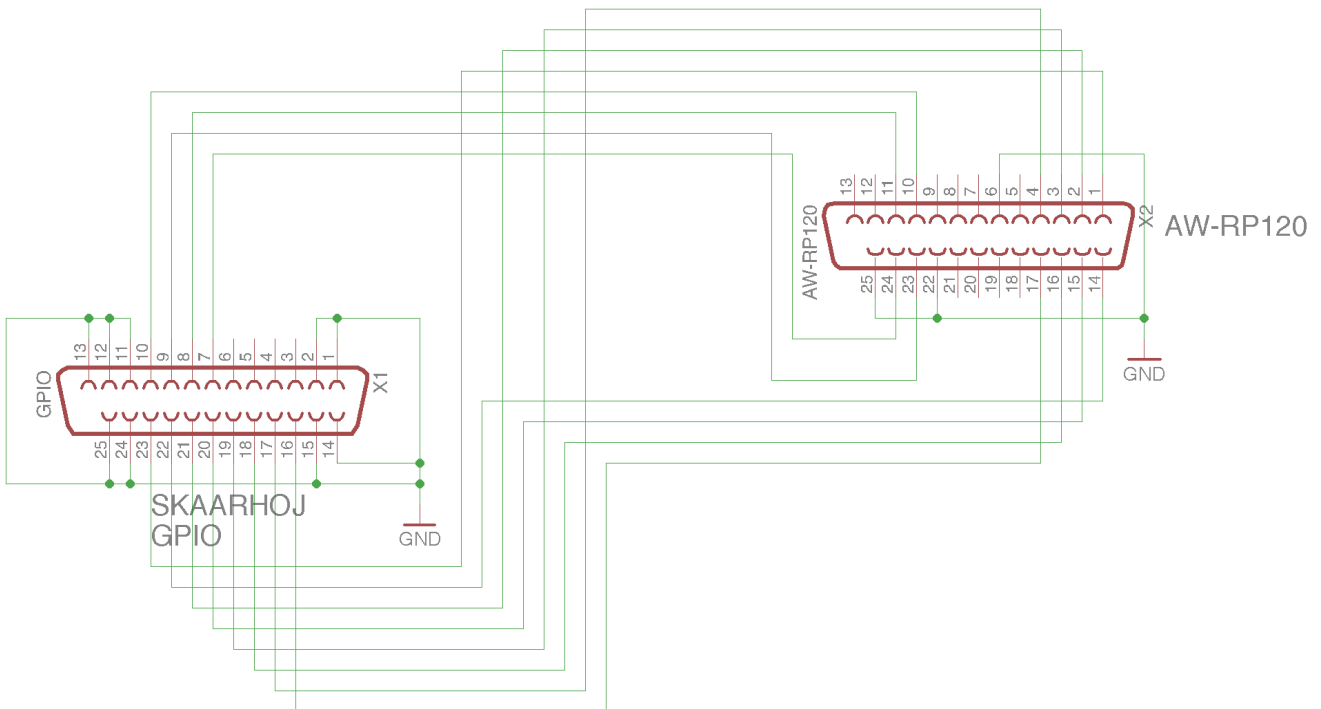

In the menu of the AW-RPx there should be a GPI Out menu. Go into this and make sure everything looks correct.

Registering camera numbers to CAM OUT1 to CAM OUT10

1. Press the MENU button.
2. Open **GPI OUT** menu [45].
3. Turn the F1 dial to display the "1. CAM OUT1" item.

4. Turn the F2 dial to select the camera number to set for CAM OUT1, and then press the F2 dial to confirm the selection.
Camera number : Select from CAM1 to CAM100.
5. Turn the F1 dial to display any of the "2. CAM OUT2" to "10. CAM OUT10" items and then register a camera number.
 - Repeat steps 3 to 4.

Connection between RCP and ETH-SDI Link using ETH2SDI Firmware

A SKAARHOJ controller such as a RCP should be configured with the "BMD CamCtrl" Device Core. In order for the device to send commands to a ETH-SDI Link the BMD CamCtrl Device Core IP should be changed from the default 0.0.0.0 to the IP address set on the ETH-SDI Link. Remember the IP address on the ETH-SDI Link and the RCP or other main controller should differ.

The screenshot shows the SKAARHOJ configuration web interface. The main heading is "Configuration of your RCPV2 with S/N #". Below this, there are three configuration options: "CCU via ATEM", "CCU via SDI" (which is selected and marked as "Active"), and "Raw Panel".

The "Network configuration" section is visible, showing "Static" IP configuration. The IP address is set to 192.168.10.99, which is highlighted with a red box. The Subnet is 255.255.255.0, Gateway is 192.168.10.1, and DNS is 192.168.10.1.

The "Devices" section shows a table of installed devices:

Enabled	Name	IP
<input type="checkbox"/>	BMD ATEM	192.168.10.240
<input checked="" type="checkbox"/>	BMD CamCtrl	192.168.10.99
<input type="checkbox"/>	BMD VideoHub	0.0.0.0
<input type="checkbox"/>	BMD SmartScope	0.0.0.0

A "Save Network Configuration" button is located at the bottom of the network configuration section.

On the main controller sending commands to the ETH-SDI Link, connection can be confirmed from the serial monitor with the message *“.BMDUDP: Connection to 192.168.10.99:5463 established!”* if the IP on the ETH-SDI Link have been set to 192.168.10.99

The screenshot shows a Serial Monitor window with the following output:

```
SKAARHOJ Controller Booting
SK_VERSION: v2.2.117
defConfigCore=159
SK_MODEL: SK_RCPV2
SK_SERIAL: None
EEPROM size: 32 KB
I2C 400 kHz mode activated
Init LEDs and buttons
Init Joystick
Calibration for analog component #1 (Fader): Start: 105, End: 112, Hysteresis: 2
Calibration for analog component #2 (Wheel): Start: 2, End: 2, Hysteresis: 2
HWVer: i255
MAC address: 90:A1:DA:97:4E:52
IP address: 192.168.10.98
Subnet mask: 255.255.255.0
Gateway: 192.168.10.1
DNS: 192.168.10.1
Memory A-D restored
Compiled: Oct 8 2018 11:28:25
DeviceCore #1: BMDCamCtrl0
setup() Done
-----
BMD#16 Down Analog: 63
System action 2
Mem A: 1
System action 17
System action 17
System action 17
System action 17
System action 17
70
.BMDUDP: Connection to 192.168.10.99:5463 established!
96
.95
.95
.95
```

The message *“.BMDUDP: Connection to 192.168.10.99:5463 established!”* is highlighted with a red box. The Serial Monitor interface includes a "Command input. Press enter to send." field and a "Commands" panel with buttons for reset, config, configd, clearpresets, debug, newmac, and ok.

Connection can also be confirmed from the serial monitor on the "ETH-SDI Link" with the message "BMDUDP: Connection to 192.168.10.98:65070 established!" if the IP on the RCP or main unit have been set to 192.168.10.98.

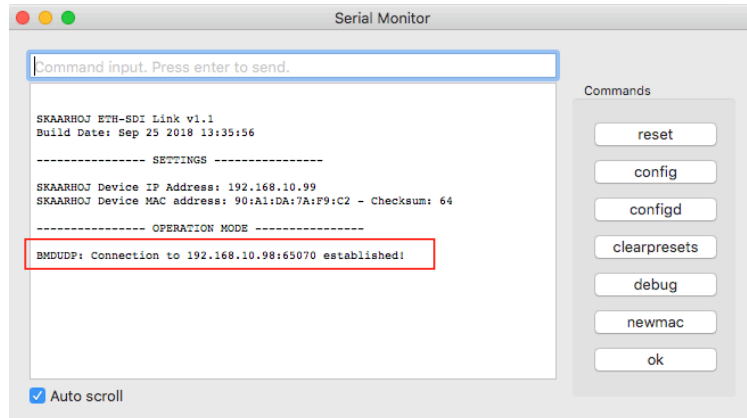

The ETH-SDI Link listens on port 5463 UDP. The RCP (or any UniSketch OS based controller) listens on return data on a random port between 50100 - 65300.

Connection between RCP and WIFI-B4 Link

The procedure have similarities with the above instruction. A SKAARHOJ controller such as a RCP should be configured with the "BMD CamCtrl" Device Core. In order for the device to send commands to a WIFI-B4 Link the BMD CamCtrl Device Core IP should be changed from the default 0.0.0.0 to the IP address set on the WIFI-B4 Link. Remember the IP address on the WIFI-B4 Link and the RCP or other main controller should differ.

WEEE Information



Figure 1

For private households: Information on Disposal for Users of WEEE

This symbol (figure 1) on the product(s) and / or accompanying documents means that used electrical and electronic equipment (WEEE) should not be mixed with general household waste. For proper treatment, recovery and recycling, please take this product(s) to designated collection points where it will be accepted free of charge.

Alternatively, in some countries, you may be able to return your products to your local retailer upon purchase of an equivalent new product.

Disposing of this product correctly will help save valuable resources and prevent any potential negative effects on human health and the environment, which could otherwise arise from inappropriate waste handling.

Please contact your local authority for further details of your nearest designated collection point.

Penalties may be applicable for incorrect disposal of this waste, in accordance with your national legislation.

For professional users in the European Union

If you wish to discard electrical and electronic equipment (EEE), please contact your dealer or supplier for further information.

For disposal in countries outside of the European Union

This symbol is only valid in the European Union (EU). If you wish to discard this product please contact your local authorities or dealer and ask for the correct method of disposal.